

Development of thin-film multi-junction thermal converters

— Establishing metrological traceability system for AC voltage standard —

Hiroyuki FUJIKI*, Yasutaka AMAGAI and Hitoshi SASAKI

[Translation from *Synthesiology*, Vol.8, No.3, p.127-144 (2015)]

Thermal voltage converters have been widely used in the electric standard field as a major method to derive AC voltage standards from DC voltage standards. However, there are only a limited number of organizations that are capable of fabricating thermal voltage converters. Furthermore, establishing AC-DC voltage standards has been constrained by the lack of high-quality thermal converters. High-quality thermal converters are used only by national metrology institutes (NMIs) because the conventional thermal converters are too fragile for many calibration laboratories. The National Institute of Advanced Industrial Science and Technology (AIST) has developed new thin-film multi-junction thermal converters (TFMJTCs) to realize a reliable high-performance thermal converter. Development of a durable TFMJTC with a heater on an aluminum nitride (AlN) substrate is expected to make significant contribution to Japanese calibration laboratories.

Keywords : AC-DC transfer difference standard, AC voltage standard, thermal converter, calibration, metrological traceability

1 Introduction

Today, the great majority of equipment used in production sites or the fields of information technology and scientific measurements employs electric signals for measurements, and it is not an exaggeration to say that voltage and current measurements have been used in most measurements. We believe that making reliable quantities of electrical standards consistently available will substantially contribute to the development of our society. The growing need these days for precisely measuring electric power, which is a derived quantity based on a voltage, current, and phase angle, has also increased the demand for improved accuracy of AC voltage standards.

A wide range of AC voltage standards is required by the industrial community. Specifically the voltages range from 1 μV used in medical equipment and micro electric power measurements, several millivolts to several hundreds of volts used in general-purpose electronic devices to several tens of kilovolts used in electric power facilities. The frequency range is also broad: 0.01 Hz used for vibration measurements, agitation of chemical agents and AC measurements of physical properties such as battery measurements, the commercial frequencies (50 Hz and 60 Hz), frequencies used for harmonics measurements (the order of 10 kHz, approximately the 100th order of the commercial frequencies), medium frequencies associated with the wireless power transmission technology (from several tens of kHz to several tens of MHz), and the order of GHz used for communications. The traceability of measurements is required for most of the range stated above.

National metrology institutes and calibration laboratories have established relevant measurement standards, operate and maintain these standards, and provide calibration services.

The method that can derive an AC voltage standard with the highest precision is the AC-DC transfer method,^[1] in which a thermal AC-DC converter (thermal converter) is used to compare an AC voltage with a DC voltage standard. Therefore, AC-DC transfer standards have been supplied as national AC voltage standards. With respect to the provision of AC-DC transfer standards, the AC-DC transfer differences of a thermal converter are calibrated, which correspond to the conversion error from a DC voltage to an AC voltage. In other words, AC standards are provided to calibration laboratories by calibrating their thermal converters. As explained below, however, the conventional thermal converters are designed in a way to achieve the highest possible precision, which causes inherent structural restrictions to make them hard to be handled owing to the vulnerability to overcurrents and impact. As a result, they have not come into widespread adoption among calibration laboratories or in the industrial community. The majority of calibration laboratories and the industrial community carry out calibrations of AC voltage standards by using standard AC voltmeters and AC generators, and therefore they fail to benefit from the biggest advantage of thermal converters, namely stability. Meanwhile the range of AC voltage standards provided by calibration laboratories to the industrial community in Japan has not been sufficient enough because it is difficult to expand the range of AC voltage standards when AC voltmeters or AC generators are used as reference.

National Metrology Institute of Japan, AIST Tsukuba Central 3, 1-1-1 Umezono, Tsukuba 305-8563, Japan

* E-mail: h-fujiki@aist.go.jp

Original manuscript received November 27, 2014, Revisions received January 27, 2015, Accepted January 29, 2015

To establish a system to provide AC voltage standards domestically, it is also important that the Japanese standard is recognized internationally. In international comparison for the AC voltage standards, a thermal converter is used as the transfer device to check the equivalence of the AC voltage standards in conjunction with the result of an international comparison of DC voltage standards. In addition to international comparison, peer review of the technological capability for AC-DC transfer standards is carried out by a standard expert to register the calibration and measurement capabilities (CMCs), which indicates the capabilities of calibrating and measuring of the national metrology institutes in various countries. The CMC is necessary for mutual recognition among the national metrology institutes in various countries, where metrological traceability systems of various countries are mutually trusted and calibration results based on the national standards of other countries are accepted by each country as they are considered equivalent to those of its own country. When a product is exported, its test report issued by a testing laboratory in an exporting country can be accepted based on inspection of records by an importing country as long as the testing instruments are traceable to relevant CMC-registered national standards.

Although thermal converters are indispensable not only for national standards but also for providing AC voltage standards to the industrial community as discussed earlier, there are only a small number of metrology institutes that are capable of providing them because of the difficulty in their fabrication. In the 1960s when the research and development of AC voltage standards based on thermal converters was actively carried out, as well as in the 1990s when improvement of the accuracy of AC voltages was conducted, there were researchers and private companies developing thermal converters.^{[2][3]} In the 2000s, however, it became difficult to obtain high-precision thermal converters because of the decline of private thermal converter manufacturers and retirements of researchers at national metrology institutes. In particular, there were no organizations that provided thermal converters capable of maintaining the highest accuracy since around 2005.

We have developed practicable thermal converters for the purpose of providing the highest-precision thermal converters that can be used for national standards. In the development, we fabricated easy-to-use, usability-oriented thermal converters by improving their performance and applying durable structure design, so that they would be widely adopted by calibration laboratories and measuring instrument manufacturers. The fabrication process was also revised and simplified to a great extent compared with the previous one so that it became easier to improve manufacturing yield and to hand down fabrication techniques, enabling stable provision of thermal converters as well as the establishment of a domestic system for AC voltage standards (Fig. 1).

2 Social objectives of AC voltage standards

In recent years, improvement of precision and reliability has been strongly demanded in measuring instruments such as voltmeters, wattmeters, electric indicators, and electronic sensors, widely used in research and development and production sites for the purpose of product quality control, performance evaluation, conformance tests, and environment monitoring. Meanwhile, the globalization and standardization of products are also advancing rapidly, which forces products made in Japan to comply not only with domestic standards but also with international standards before they are exported. At present, manufacturers are strongly required to address product liability of their products nationally and internationally and assure the measurement results delivered by inspections. Electrical products are required to undergo product inspection including voltage tolerance tests when being shipped, and it is important to ensure the reliability of the measuring instruments used for such inspection. For instance, UL standards issued by Underwriters Laboratories Inc. (UL), a safety assessment institution, requires measuring instruments used for inspecting electrical appliances used in the United States to be traceable to the national standards. If there is serious discrepancy in measuring results due to

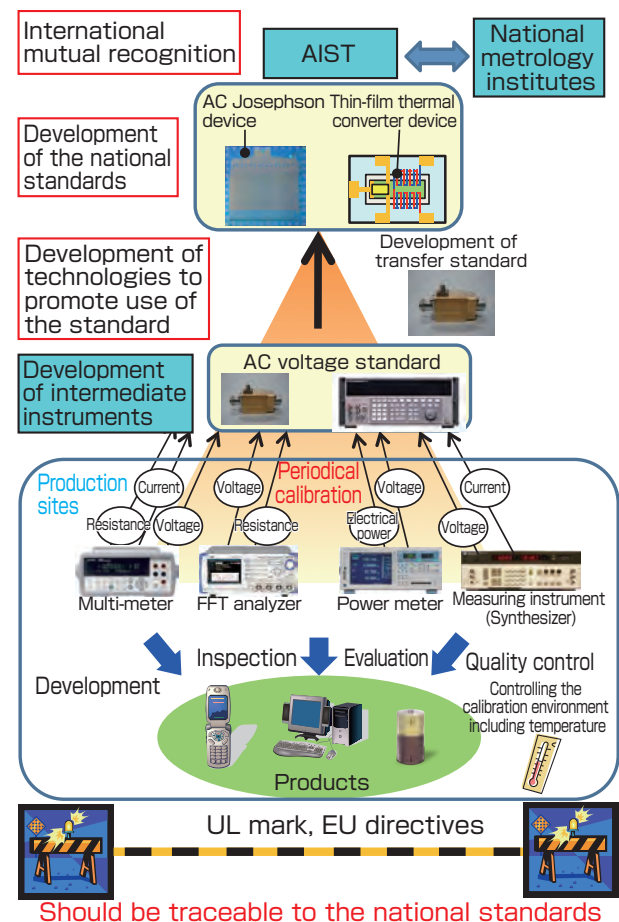

Fig. 1 Scenario to establish the domestic system for the AC voltage standard

the failure of measuring instruments, products may not be allowed to be exported to the United States. In Europe, the Communauté Européenne (CE) marking scheme has been implemented as well.

Measuring instruments required to be traceable to the national standards must be calibrated regularly (usually once a year) to guarantee results of inspections and measurements. Figure 2 shows the traceability system of electric power meters as an example where the calibration of the AC voltage standard is demanded. Submission of traceability system charts is frequently requested by customers when products are exported or examined or when some regulations are applied.

The upper-tier reference standards^{Term1} managed by quality assurance departments in companies and inspection equipment used in industrial operations are not quite stable owing to physical disturbance such as ambient temperature, humidity, and vibration, and therefore their output values are influenced by such external factors. To address this problem, the quality assurance department in charge of products needs to have relevant measuring instruments calibrated periodically to maintain their reliability. In general, the quality assurance department uses the upper-tier reference standards of the company to periodically calibrate their working standards that are used for inspections in their manufacturing. The upper-tier reference standards of the quality assurance department are, in turn, calibrated by an external third-party calibration laboratory, which is traceable to a national metrology institute. In this way, as shown in Fig. 1, the traceability of inspection equipment used in production sites is established.

Most measuring instruments used in production sites are fixedly installed in production lines or other locations and kept stationary as much as possible. Measuring instruments, therefore, are usually calibrated in place under field environment. Quality assurance departments of companies manage their calibration facilities by giving consideration to stability of the calibration equipment, physical disturbance, and degradation of calibrated values over time. Ensuring reliability of the calibration equipment is important to avoid the delay of product delivery caused by imperfection in inspection before shipment since customers frequently request quick delivery. Manufacturing companies receive many inquiries concerning conformance to specifications and pirated goods. Measurement traceability is essential to assure inspection results of the products in question. As explained above, quality assurance departments use calibration services provided by calibration laboratories to manage values given by their calibration instruments. Additionally, in the case of AC voltage standards, specific measurement techniques need to be adopted to appropriately address the effects of stray capacitance, impedance characteristics, load effects, and reflections. In the high frequency range, measurement results can easily change due to a slight difference in the measurement conditions. There is, therefore, the strong need for reliable upper-tier reference standards to ensure the validity of the company's measurement capability. In addition, there is an increasing demand for stable easy-to-use equipment. It is not unusual that tens to hundreds of measuring instruments need to be traceable to the national standards in a production site. For the entire manufacturing industry, therefore, the development of stable and easy-to-use measuring instruments is critical to reduce the workload and expenses associated with the calibration of measuring instruments and the management of production

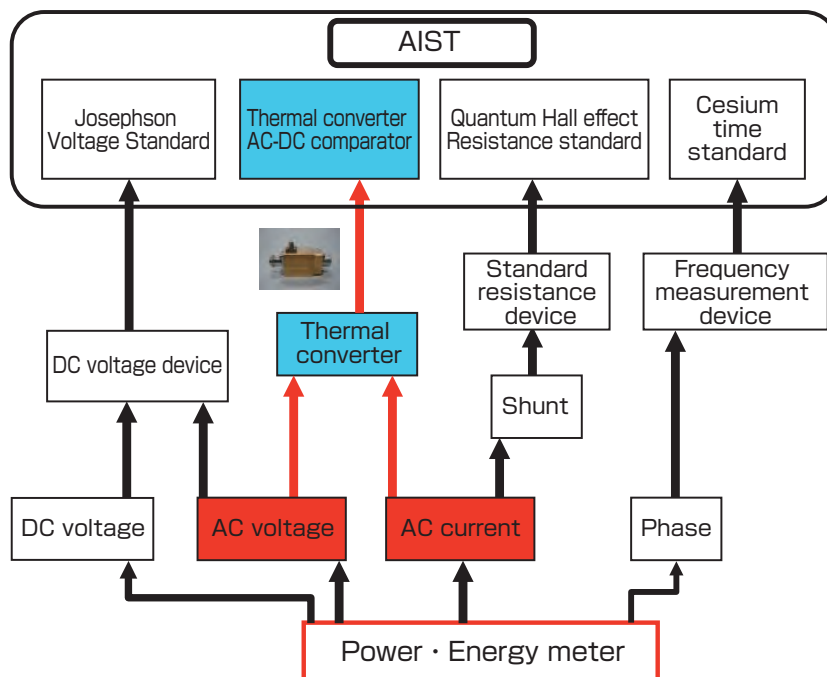

Fig. 2 Traceability system of power meters and energy meters

lines, which is expected to contribute to the improvement of competitiveness. As the reliability of measurements is essential for the improvement of product quality, standardization, security and safety, there is an urgent need to realize stable provision of the electric standards.

3 AC-DC transfer standards used to derive AC voltage standards

AC voltage and current standards are physical standards widely used as base quantity in the electrical industry including the electronics industry, the electric power energy industry and the electronic information communications equipment industry. On the other hand, AC-DC transfer standards are not familiar to the general public. There are only a few guides for AC-DC transfer standards written in Japanese. This chapter briefly explains the theory and techniques of AC-DC transfer standards and thermal converters, which constitute the basis of the remainder of this article.

3.1 AC-DC transfer standard

AC voltage standards are derived by comparing a DC voltage with an AC voltage via an AC-DC thermal converter. Heat plays a key role in this comparison. In accordance with the law of conservation of energy, it is defined that an AC voltage and a DC voltage are equal to each other when the amounts of heat generated by the heater in the converter are identical between the AC and DC voltages. The rms value of an AC voltage and that of a DC voltage can be compared on the basis of this definition, which in turn allows an AC voltage to be derived from a DC voltage. The system based on this comparison method is referred to as the “AC-DC transfer standard,” and the value corresponding to the conversion error from a DC voltage to derive an AC voltage is referred to as an “AC-DC transfer difference.” Up to the present, an AC voltage standard is established most accurately when it is derived from a DC voltage standard (Josephson voltage standard) via a thermal converter. This method is widely used by NMIs^[1] (Fig. 3). In order to establish an AC voltage standard, therefore, the evaluation of AC-DC transfer differences of thermal converters as well as the development of a thermal converter is essential. For this reason, every national metrology institute has its own AC-DC transfer

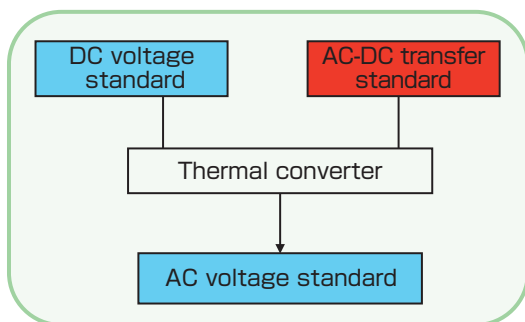

Fig. 3 Flow to derive the AC voltage standard

difference standard. The development of a thermal converter which features limited AC-DC transfer difference and is capable of evaluating AC-DC transfer difference is necessary for expanding the range of AC voltage standards in national standards and enhancing their performance. Although this is an important research subject, there are only a small number of metrology institutes that are capable of fabricating such a thermal converter. Consequently it is difficult to obtain high quality thermal converters consistently. Meanwhile the stable provision of thermal converters is indispensable to maintain and manage AC standards because thermal converters can be broken or deteriorated in the course of calibration operations. The stable provision is also necessary to make AC voltage standards with low uncertainty available to calibration laboratories.

The causes of an AC-DC transfer difference are listed below since it is necessary to take into account the major factors of AC-DC transfer differences of thermal converters when the elemental technical challenges are discussed in Chapter 5. A thermal converter detects rises in temperature, with a thermocouple, induced by the Joule effect which is caused by the input voltage applied to a heater. Major AC-DC transfer differences of a thermal converter can be classified into the following three categories:

- (I) Thermoelectric effect (dc offset): When a DC current flows through a thermal converter device, non-Joule heating/cooling occurs due to the Thomson and Peltier effects, which makes temperature distribution of the heater wire uneven. As a result, even when an AC sinusoidal wave voltage featuring the same rms value as a DC voltage is applied to the heater wire, the thermocouple outputs different voltages, which causes an AC-DC transfer difference (thermoelectric effect).^[4]
- (II) Low frequency characteristics: When the frequency of input AC voltage is not sufficiently higher than the thermal time constant of the thermal converter, the temperature of the heater wire changes along with the input voltage, causing periodical temperature variations (thermal ripples), which results in an AC-DC transfer difference.
- (III) High frequency characteristics: In the frequency range of 10 kHz or higher, the frequency characteristic of AC-DC transfer difference is observed because the influences of the skin effect, stray capacitances in the input circuit and inductances cannot be eliminated from the device. At frequencies higher than 1 MHz, impedance matching needs to be taken into account.

Due to the causes listed above, the AC-DC transfer difference of an ordinary thermal converter features the frequency characteristics shown in Fig 4. In the frequency range from

100 Hz to 10 kHz, the high frequency characteristics and the low frequency characteristics are relatively small, and therefore the “thermoelectric effect” induced by non-Joule heat is dominant. While the AC-DC transfer differences described in (II) and (III) are evaluated by theoretical models, the AC-DC transfer difference described in (I) is evaluated by the FRDC-DC method, which is used to measure thermoelectric effect.^{[5]-[7]}

3.2 Thermal converter

To date, four types of AC-DC converters have been developed: single-junction thermal converter (SJTC),^[8] multi-junction thermal converter (MJTC),^[9] thin-film multi-junction thermal converter (thin-film MJTC)^{[10][11]} and solid-state thermal rms sensor.^[12]

(1) Single-junction thermal converter (SJTC)

A single-junction thermal converter element (Fig. 5) is composed of a heater wire and a thermocouple. It is called “single-junction thermal converter” because a single thermocouple pair is used. The heat generated in the heater wire by an input DC voltage and that by an input AC voltage are measured with the thermocouple for comparison. To maintain the electrical insulation, the thermocouple is attached to the heater wire through an insulating bead. The heater wire and thermocouple are sealed in a vacuum glass bulb to improve the thermal insulation from outside. The length of the heater wire is designed to be short in order to

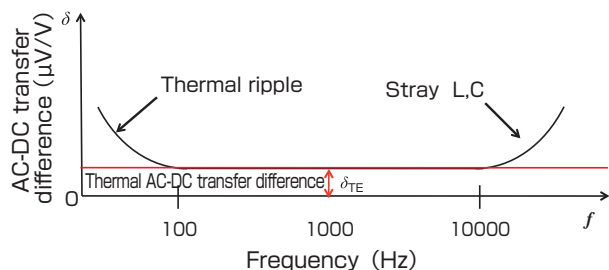

Fig. 4 Frequency characteristics of the AC-DC transfer difference of the thermal converter

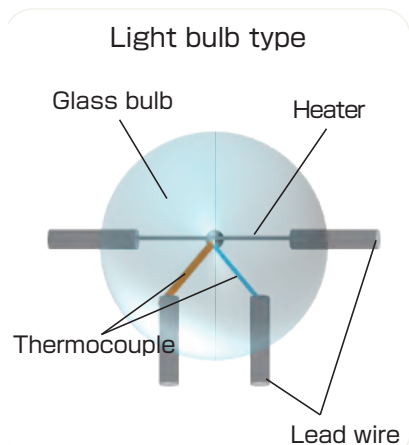

Fig. 5 Schematic diagram of a single-junction thermal converter (in a miniature bulb structure)

minimize the influences of stray inductance and capacitance and address the influence of reflections caused by impedance mismatch at high frequencies. The heater wire features a fine-line structure with a diameter of about 25 μm to suppress the influence of the skin effect and increase the resistance to a certain extent. The rated current is about 10 mA. The heater wire can be deteriorated or broken as it generates heat due to overcurrents. Since both the heater wire and the thermocouple feature a fine-line structure, single-junction thermal converters need to be fabricated manually under a microscope, which makes it difficult to mass-produce them and improve the yield.

Single-junction thermal converters came into use for measurements with accuracy of 1 ppm-level back in 1960s, and are still widely used in the field of AC voltage standards. Due to its simple structure, the SJTC elements feature small frequency characteristics up to high frequencies of about 1 MHz. The long-term drift of the AC-DC transfer difference is negligibly small. An AC-DC transfer difference, however, is generated by non-Joule heating or cooling which is induced by the Thomson and Peltier effects caused by the temperature distribution of the heater wire.

(2) Multi-junction thermal converter (MJTC)

Multi-junction thermal converters were developed to solve the problem of thermoelectric effect, which was particularly difficult to be evaluated. When the heater wire is straight in shape, temperature gradient is generated between high and low sides of the applied voltage. As shown in Fig. 6,^[9] a multi-junction thermal converter adopts a stranded heater wire structure to reduce the unevenness of heat. In addition, a large number of thermocouples are used to uniform the temperature distribution of the heater wire, by which thermoelectric effect can be suppressed to 0.1 μV/V or less. Using a number of thermocouples makes it easy to measure AC-DC transfer differences because the output voltages increase to about 100 mV. However, the structure of a multi-junction thermal converter is the most complicated among thermal converters. To construct this structure, it is necessary to attach thermocouple wires with diameter of 20 μm to heater fine wires with diameter of 10 to 40 μm under a microscope,

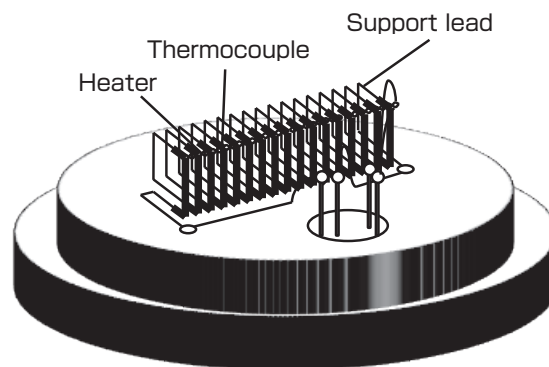

Fig. 6 Schematic diagram of a wired multi-junction thermal converter

which makes it difficult to mass-produce them. About 100 multi-junction thermal converters have been fabricated up to now, and one or two of them have been distributed to each of major national metrology institutes. Meanwhile multi-junction thermal converters cannot be used frequently since they are easily broken due to electric breakdown by static electricity. In calibration operations, therefore, single-junction thermal converters and thin-film multi-junction thermal converters to be explained next are usually used. In addition, the high frequency characteristics of multi-junction thermal converters are inferior to those of single-junction thermal converters owing to the complicated structure. Currently, wired multi-junction thermal converters are not in production.

(3) Thin-film multi-junction thermal converter (thin-film MJTC)

The development of thin-film multi-junction thermal converters (Fig. 7) started in the latter half of the 1980s when advanced micromachining technology was in wide use. A thin-film multi-junction thermal converter is a thin-film version of a wired multi-junction thermal converter which is very hard to be fabricated. The thin-film type generally has the structure of the multi-junction thermal converter to improve the small output, a weak point of SJTCs. This is why it is referred to as a thin-film MJTC in the world of standards. Thin-film thermal converters often adopt a loopback U-shaped heater structure to improve the unevenness of the temperature distribution. In the case of thin-film thermal converters the thickness of the substrate immediately below the heater needs to be adjusted to ensure thermal insulation around the heater. To make this adjustment possible, in the early 1990s, a technique was developed to deposit a thin film over a silicon substrate on which the area under the heater film was anisotropically etched. Thanks to this technique, thin-film multi-junction thermal converters were broadly adopted by national metrology institutes. However, the high frequency

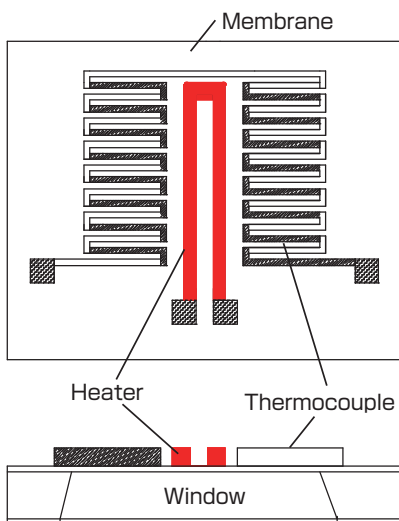

Fig. 7 Schematic diagram of a thin-film multi-junction thermal converter

characteristic of a thin-film thermal converter is also inferior to that of an SJTC because of its complicated structure. At frequencies of 10 kHz or higher, the reproducibility of the frequency response of AC-DC transfer differences becomes deteriorated due to the effect of stray inductance and capacitance. Similar to SJTCs, it is not so easy to change the structure. The rated current of a thermal converter is about 10 mA. The wire will become broken when an overcurrent flows.

(4) Solid-state thermal rms sensor

Solid-state thermal rms sensors were developed by a U.S. measuring instrument manufacturer as practicable substitutes for single-junction thermal converters and multi-junction thermal converters. A solid-state thermal rms sensor does not employ a thermocouple but uses the temperature dependence of the base-emitter junction voltage V_{BE} of a transistor as the temperature sensing device to detect the temperature rise of the heater. The AC-DC transfer difference at around 10 Hz sometimes reaches the order of 100 $\mu\text{V}/\text{V}$ because of the low thermal time constant. The thermal AC-DC transfer difference of a solid-state thermal rms sensor is a bit larger than that of a multi-junction thermal converter, and its uncertainty is a little higher. However, commercially-available solid-state thermal rms sensor type thermal converters are hard to be broken because of an embedded protection circuit against overcurrents. In addition, as a high-performance amplifier is used, the output voltage is high, which makes the measurements easier. The most common thermal converters among calibration laboratories are those using a solid-state thermal rms sensor. In order to use thermal converters as national standards, they must have a low uncertainty of the AC-DC transfer difference. It is also required that the frequency characteristic and other parameters of the AD-DC transfer difference can be evaluated. Therefore, solid-state thermal rms sensors have been commonly used as standards at calibration laboratories.

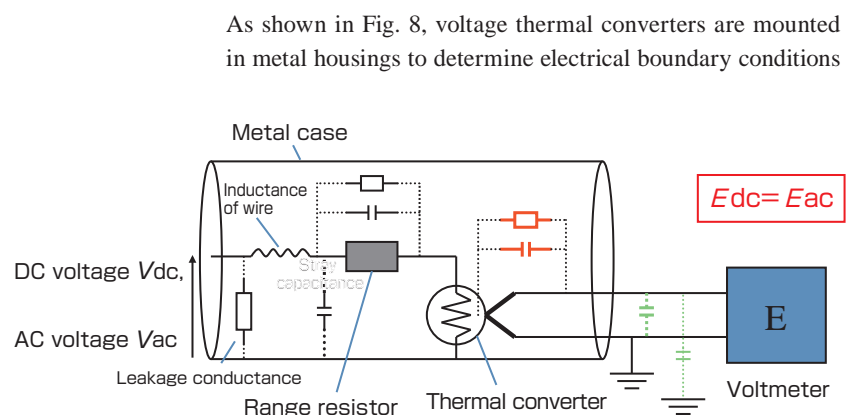

Fig. 8 Example of how a thermal converter is mounted

In order to expand the AC voltage range, the range resistor is placed in a metal housing and connected to the thermal converter in series. This made it possible to determine the frequency characteristics of the AC-DC transfer difference including the stray capacitance, stray inductance and parasitic resistance shown in the figure.

including the stray capacitance. The voltage is expanded by connecting resistors for dividing the voltage, namely range resistors, in series because the resistance of the heater in a thermal converter device is about 25 to 100 Ω due to structural restrictions. By using this method, the AC-DC transfer difference of the thermal converter, with the range resistors included, can be expanded up to 1,000 V.^[13] AC voltage standards that can be established by an AC-DC transfer difference technique range between the orders of 1 mV and 1 kV in voltage and between the orders of 0.1 Hz and 100 MHz in frequency. Beyond these ranges, other methods have been adopted, i.e., a transformer or a thermistor is used or a sampling method is employed.^{[14][15]} Recently, NIST has conducted the research and development to expand the frequency to the GHz order by using a thermal converter.^[16]

4 Scenario for establishing AC voltage standards

The scenario required for establishing a domestic system of AC voltage standards consists of international mutual recognition, establishment of a high-precision national standard and provision of the standard to the industrial community (Fig. 1).

The project for expanding the range of the AC-DC transfer standards in Japan was launched in 2001 to address international mutual recognition and requests from the industrial community. The ranges of the AC-DC transfer standard provided in 2001 were 2 to 20 V in voltage and 40 Hz to 100 kHz in frequency, which were narrower than those of the AC-DC transfer standards provided by other countries' national metrology institutes. Moreover, the best measurement capacity was 10 ppm, which means that the uncertainty was also a bit high. In this situation, improvement of AC voltage standards was desired. While "development of a new standard device" is required for establishing a national standard, "development of utilization promotion technique" of the national standard is important for the proliferation of the calibration. Therefore, as shown in Fig. 1, the research and development of the national standard and the development of the utilization promotion technique of the standard must be carried out in parallel.

4.1 Establishment of the national standard

There are two approaches to derive AC voltage standards: 1) creation of ideal AC waveforms and 2) use of the AC-DC transfer method (Fig. 9). A universal standard that is reproducible, regardless of the time, place, and operator, and that features low uncertainty is desirable as the national standard. From this perspective, the quantum standard is ideal for the national standard of AC voltage standards. A representative example of the invention based on this method is shown in Fig. 9-1: to generate AC waveforms by using a Josephson DC voltage standard to vary the output values over time (AC voltage Josephson standard).^[17] The existing DC

voltage standards are realized by using the Josephson effect, which is a quantum phenomenon. Josephson DC voltages are determined by the number of junctions and the frequency of the microwave irradiated, which means that a very accurate voltage can be obtained if the frequency of the microwave is set accurately.^[18] Currently, major national metrology institutes are conducting the research and development to create ideal AC voltages by using the Josephson effect. Also in the National Institute of Advanced Industrial Science and Technology (AIST), the DC voltage standard group has been taking the leading role in the development of AC voltage Josephson standards as candidate national standards of AC voltages.^[19] Precisely speaking, AC voltages produced by this method have a stepwise waveform, but the voltage goes out of the quantized voltage in each step momentarily during the transition of the voltage, causing transient errors. To resolve this problem, the ways to avoid the transient errors are being studied. Even if AC voltage Josephson standards are realized, however, their voltage and frequency ranges are considered to be limited. In addition, there are some difficulties in using them in actual calibration operations in industrial operations. Currently, on top of the research and development to generate ideal AC waveforms, a system to calibrate AC voltage measuring devices and generators accurately is being developed by using an AC voltage Josephson standard and a thermal converter in combination.^[20] The advantages of this method are twofold: 1) the uncertainty of the thermal

① Direct synthesizing of sine wave

Micro wave (standard frequency)

Josephson device

The output value is varied to generate AC waveforms

Advantages:

- By using the quantum standard, **universal physical phenomenon is used as the basis.**
- Uncertainty is improved

Disadvantage:

- The range of the standard is narrow and it is difficult to expand the range of voltage and frequency
- It is difficult to be used in the calibration sites.

② Comparison of AC and DC quantity

AC voltage standard is derived by comparing root-mean square value between AC- and DC voltage by converting the power to heat. The thermal converter is capable of comparing the joule heating between AC and DC voltage.

Method for realizing the rms value of AC voltage

Advantages:

- This method enables us to expand the voltage and frequency range.**
- The cost of calibration service can be suppressed.

Disadvantage:

- It is difficult to purchase a high quality thermal converter.
- The evaluation of AC-DC transfer difference is required.

Fig. 9 Method for realizing the AC voltage standard

converter can be reduced and 2) the current system to provide AC voltage standards can be utilized.

The top-tier AC voltage standards currently available are realized by using the AC-DC transfer method shown in Fig. 9-2, which could remain as the national standard in the future because the transient errors of AC voltage Josephson standards are still unsolved. In order to use a thermal converter as a national standard, it is indispensable to evaluate the causes of the AC-DC transfer difference discussed in Chapter 3 and to improve its uncertainty, because the frequency characteristic of the AC-DC transfer difference varies depending on the resistor value and stray capacitance. (For a thermal converter used as a national standard, the value of the AC-DC transfer difference must be evaluated independently as the start point of the AC-DC transfer difference, rather than being calibrated by another standard.) Therefore, multiple thermal converters featuring different resistance and shapes are fabricated, so that the value of the AC-DC transfer difference can be determined by evaluating the variations in their AC-DC transfer differences. Similarly, in order to expand the range of AC voltages, thermal converters that can deal with the causes discussed in Chapter 3 must be fabricated. It is clear that multiple thermal converters with different characteristics need to be made available to establish the national standard. The reality was, however, that high-performance thermal converters were not easily available and therefore it was necessary to develop thermal converters for the scenario of the AC voltage system, as discussed above.

4.2 Utilization promotion technique for the national standard

Standard devices demanded by the industrial community are those that are affordable and usable in a wide range without placing a significant burden on the operation and maintenance. It is rare that the industrial community demands uncertainty equivalent to that of the national standard. Even in the case of the resistance standards with which quantum Hall effect is utilized^[18] and the Josephson DC voltage standards, values provided by quantum standards are, for example, 10 k Ω and 10 V only, and a resistance bridge or a voltage divider is used to expand the range beyond. From the perspective of provision of standards, the quantum standards become less significant because it is not practical or realistic for quantum standards to cover the entire range of standard provision since there are other methods which easily realize these standards. As for AC voltage standards, as in the case with the resistance and DC voltage standards, even after quantum AC voltage standards are established in the future, low-cost and stable standard devices will be still necessary to expand the voltage range and calibrate measurement instruments used in the industrial community. Even when AC-DC transfer standards are replaced by AC voltage Josephson standards as the national standard, thermal converters will likely be continuously used for expanding the calibration services. In fact, in the field of the conventional DC voltage standards, the highest-precision

calibration requests are made for Zener voltage standard devices. It can be anticipated that calibration requests for thermal converters will be continuously made in the field of AC voltage as well.

To expand the calibration services for AC voltage meters and generators to the industrial community, low-cost, robust, easy-to-use standard devices with a small degree of drift are essential. In implementing the scenario for the proliferation of standards, even when a sophisticated national standard is established, the industrial community cannot utilize calibration services unless appropriate standards traceable to the national standard are made available. If AC voltage meters or generators used in inspection sites for general industrial products were employed as the standards, they might not be able to fully benefit from the sophisticated national standard because of the possible degradation of the calibration values caused by long-term drift and disturbance such as temperature and humidity. High-performance thermal converters are stable with less than 1 ppm of long-term annual drift in the AC-DC transfer difference at about 1 kHz, and feature very little voltage dependency. If calibration laboratories and calibration departments in companies can use a thermal converter as a standard, they can obtain a high-precision, stable standard. If AC voltage values of an AC voltmeter instead of thermal converters are used for calibration, it will become difficult to further expand the range of calibration with low uncertainty, which may pose the risk to narrow the range of calibration services provided to the industrial community. Meanwhile the conventional thermal converters were fragile and could be damaged even when they were handled with care. It was necessary, therefore, to improve the durability of thermal converters in order to expand the range of calibration services provided to the industrial community. In addition, the rated voltage of the conventional thermal converter was 1 V, and therefore a range resistor needed to be used to expand the range. So there was a need to expand the voltage range of a thermal converter. The development of a new thermal converter is also in line with the objectives of the stable provision of AC voltage standards to the industrial community and further proliferation. As discussed above, as a challenge of the calibration techniques for the industrial community, it was considered necessary to develop a thermal converter that can be used as a standard.

5 Development of a thin-film thermal converter

To realize the national standard and extend the calibration services of AC voltage standards, we have developed a technique to fabricate thermal converters easily and designed a new thermal converter that can solve performance issues. The development of a thermal converter practicable enough to be used in the industrial community makes it possible to establish and maintain the national standard, and provide a

high-precision standard to the industrial community.

5.1 Elemental technical issues

We have developed a new thermal converter as we believed that the fabrication of a thermal converter would contribute a lot to the establishment of the AC voltage standard system when we looked at the scenario for deriving the AC voltage standard discussed in Chapter 4. In this section, the technical issues in relation to the fabrication of thermal converters are presented.

(1) Issues in the fabrication method

In the case of a single-junction thermal converter having a miniature bulb structure (Fig. 5), although it is desirable to use platinum, which can suppress the Peltier effect and features a similar coefficient of thermal expansion to glass bulbs, for the pole to support the heater wires, highly-skilled craftspersons need to be used to weld platinum to Evanohm®, the material of the heater wires. Moreover, there are only a few craftspersons in the world who are capable of fabricating high-quality single-junction thermal converters because it is difficult to mount thermocouple leads with diameter of 20 μm at the very center of the heater fine wire with diameter of about 25 μm and seal them in vacuum. We have not been able to purchase thermal converters in which a platinum wire is used since 2005.

A thin-film thermal converter shown in Fig. 7 also had some issues in its fabrication. PTB, a German national metrology institute, fabricated thin-film thermal converters by forming a heater thin film on a silicon substrate and used them for the standard provision. The operating principle of a thermal converter is based on the measurement of temperature rise in the heater wire. In order to ensure the thermal insulation around the heater film, the silicon substrate immediately below the heater film is chemically etched, which makes that part of the substrate becomes thinner. This structure applies excessive stress to the heater film, and therefore a buffer layer needs to be deposited to relax the stress. Without a buffer layer, cracks were sometimes developed on the heater film and thermocouple film. As discussed above, the fabrication of a thermal converter requires specific know-how including the conditions of etching and buffer layer growth. On top of that, the method to fabricate resistive thin films with a low temperature coefficient and the technique to fabricate the thermocouple thin film composed of specific materials needed to be established because the temperature coefficient of the heater film and the output characteristics of the thermocouple film have influences on the AC-DC transfer difference. The PTB-type thin-film thermal converter shown in Fig. 7 has been also hardly available because the staff member in charge left PTB.

(2) Technical issues with thermal converters

It is also important to discuss the design of thermal converters. The conventional thermal converters had a couple of challenges: difficulty in the fabrication due to their structure and limitation in their performance. The conventional thermal converters are designed in a way to achieve the highest precision of AC voltage standards. Single-junction thermal converters have a short heater wire to achieve a frequency characteristic suitable for the evaluation of uncertainty at high frequencies of 10 kHz or higher. Since the wavelength of AC voltage at 1 MHz is about 300 meters, a heater wire of a few centimeters in length is equivalent to a few ppm order when the ratio of the wavelengths of the input frequencies is applied. When a ppm-order uncertainty is required for AC voltages, a shorter heater wire is more suitable because a lumped constant model can be used for calculation. In order to increase the input resistance of the circuit so as to observe the heat generated by the heater, however, the heater wire must be fine enough to achieve resistance of about 25 to 90 ohms. Use of the fine heater wire also makes the evaluation of the uncertainty derived from the skin effect easier. On the other hand, the current level is limited to about 10 mA because the heater wire is surrounded by the vacuum, and the heater wire may be burnt off if an overcurrent exceeding the rated current by a few percent is applied. As it is difficult to change the structure of a single-junction thermal converter, its resistance and thermal time constant are hard to be changed. As a result, range resistors are needed to achieve a required input voltage. Also uncertainty gets higher at 100 Hz or lower due to the low-frequency characteristic discussed in Subchapter 3.1 (II).

The major objective of fabricating conventional thin-film multi-junction thermal converters (Fig. 7) was to evaluate the thermal AC-DC transfer difference described in Subchapter 3.1 (I). To achieve this objective, a hundred thin-film thermocouples are fabricated along the heater wire. When the frequency increases, electrical insulation gets weaker owing to the unavoidable capacitance between the heater and the thermocouples, resulting in a leakage of the input current into the measurement circuit on the thermocouple side.^[21] As the amount of the leakage current is determined by the circuit to measure output from the thermocouples, reproducibility gets poorer, by which the uncertainty gets higher. Since many thermocouples are used, the resistance of the thermocouples amounts to about 10 k Ω , which causes noises when the output voltage of the thermocouples is measured. In the case of thin-film multi-junction thermal converters, the rated current is also limited to about 10 mA and the thermal time constant is not easy to be changed.

One of the subjects for provision of calibration services in the industrial operations is the differences in the calibration environment. If AC-DC transfer difference of a thermal converter used in an industrial operation is considerably dependent on temperature and/or humidity, the reliability of calibration results may be deteriorated even when it is

Table 1. Technological elements for development of thermal converters

Elemental technology	Summary of development	Reasons/ grounds for setting	Relevant figures/ tables
(1) Issue in fabrication method: Simplification of fabrication	The conventional thermal converter in a miniature bulb structure is fabricated manually under a microscope by craftspersons, and therefore high level of skills are required. The fabrication method needs to be simplified.	Thermal converters are hard to obtain due to difficulty in their fabrication. Only limited organizations, even among national standard organizations, can fabricate thermal converters.	Fig. 5, Fig. 12, Table 2
(2) Issue in fabrication method: Adoption of thin films in a thermal converter	The etching technique is required for the conventional thin-film thermal converters. In addition, some sources of uncertainty of the AC-DC transfer difference are derived from structural restrictions.	A small thermal converter is required so that it can be used in general measuring instruments. In order to facilitate the use of thermal converters in industry, thermal converters with better usability need to be provided.	Fig. 7, Fig. 11, Fig. 12, Fig. 13, Table 2
(1) Technical issue: Improvement of the high frequency characteristics of the AC-DC transfer difference	In the conventional thermal converter, input current of a heater wire leaks into the measurement circuit on the thermocouple side due to stray capacitance between a heater and a thermocouple, causing poor reproducibility in the high-frequency region and becoming a major source of uncertainty.	Excellent reproducibility is required for a thermal converter to be used as the national standard. Calibration in the high frequency region is difficult even for the calibration laboratories. The high frequency characteristics need to be improved.	Fig. 7, Fig. 14
(2) Technical issue: Improvement of the heater resistor in a thermal converter	The heater resistance value of the common thermal converter is restricted, and the input voltage is limited. Through change in the structure of the thermal converter, a desired resistance value can be selected. In addition, precision may be degraded in the low frequency region by the fluctuation of temperature and variation of resistance value of the heater wires. The heater resistor needs to be improved.	For calibration laboratories, thermal converters that can be used in a wide voltage range are useful. In addition, it is desirable that uncertainty associated with calibration be small.	Table 2
(3) Technical issue: Improvement of the thermal AC-DC transfer difference	The AC-DC transfer difference at around 1 kHz represents one of the important performance indicators of a thermal converter. If the AC-DC transfer difference at 1 kHz is 1 ppm or below, the thermal converter can be used as the high performance national standard instrument.	For thermal converters that can be used as the national standards, the AC-DC transfer difference at 1 kHz should be 1 ppm or below.	Fig. 16, Fig. 17
(4) Technical issue: Improvement of durability	The rated current of a thermal converter is as small as 10 mA, and even a slight overcurrent can cause disconnection and destruction of heater wires. For wider use of thermal converters in the industry operations, durability of thermal converters needs to be improved.	Calibration laboratories and businesses often perform considerable number of calibrations. Thermal converters, therefore, must be hard to be broken.	Fig. 19, Table 2
(5) Technical issue: Improvement of low frequency characteristics of a thermal converter	When the thermal time constant of the thermal converter is in the order of 0.1 second, the AC-DC transfer difference increases at low frequency of 100 Hz or below, which will increase uncertainty of calibration. It is necessary, therefore, to improve the low frequency characteristics.	To improve uncertainty of AC voltage at the commercial frequency, it is necessary to improve the AC-DC transfer difference at low frequency of 100 Hz or below.	Fig. 17, Table 2
(6) Technical issue: Improvement of resistance of a thermocouple	The SN ratio is proportional to the output voltage, and inversely proportional to the square root of the output resistance R. When multiple thermocouples are mounted, the resistance value gets to 10 kΩ and the detection sensitivity is degraded. In order to improve the SNR, the resistance of thermocouples needs to be reduced as much as possible.	When the AC-DC transfer difference is evaluated at the ppm level as the national standards, the detection sensitivity needs to be high.	Fig. 10, Table 2
(7) Technical issue: Frequency characteristics of the AC-DC transfer difference of thermal converters	In order to improve ease-of-use of thermal converters to facilitate their wider use in the industry, frequency characteristics need to be made flat. The frequency characteristics (10 Hz to 1 MHz) of the AC-DC transfer difference need to be improved.	In the case of calibrations carried out in the industrial operations, it is desirable that the thermal converter features less-varied frequency characteristics in order to detect shift of calibration values caused by changes in the calibration conditions.	Fig. 17, Table 2
(8) Technical issue: Evaluation of environmental resistance of a thermal converter	Unlike in a calibration room, the environmental conditions including temperature and humidity may not be sufficiently controlled in the industrial operations. The environmental resistance of thermal converters needs to be evaluated and used as indices for use of thermal converters.	To promote usage of the standards in the industrial operations, it is important to evaluate the stability of thermal converters against environmental conditions.	Fig. 20, Fig. 21

calibrated periodically. In addition, if the AC-DC transfer difference features significant frequency characteristic, sometimes it can be difficult to notice deviations in calibration values attributed to the measurement conditions including the effect of cable length and the temperature changes. It is desirable, therefore, that thermal converters feature small frequency characteristic of the AC-DC transfer difference.

The technological elements for the development of thermal converters discussed above are summarized in Table 1. The conventional single-junction thermal converters and multi-junction thermal converters, which are hard to handle, are primarily used in national metrology institutes where the highest-precision is required. In the industrial community, while the proliferation of those thermal converters is very limited, solid-state thermal rms sensors are commonly used among the four types explained in Subchapter 3.2. However, solid-state thermal rms sensor type thermal converters need to be calibrated by other national metrology institutes because their structure does not allow direct determination of the causes of the AC-DC transfer difference discussed in (I) to (III) of Subchapter 3.1. The industrial community uses solid-state thermal rms sensor type thermal converters, which are calibrated by calibration laboratories using a single-junction thermal converter or a multi-junction thermal converter.

5.2 Design and development of a thermal converter

Change of the fabrication process, including simplification of fabrication, is required in order to solve the technical issues for the thermal converters described in Subchapter 5.1. The conventional thermal converter consists of a heater wire and a thermocouple, both of which are integrated into one body, and a failure of either component, if any, would result in malfunction of the thermal converter. There is also a problem in the actual fabrication. Since a heater wire and a thermocouple are fabricated on a same substrate, even if fabrication of either component succeeds in the preceding process, it can be degraded or damaged due to impacts of the subsequent process, which may result in yield drop. To address these problems, a new thermal converter is designed in a way to fabricate a heater and a thermocouple on two separate substrates. This design allows to realize the optimal fabrication conditions of a heater wire and a thermocouple independently, by which they do not affect each other. As a result, it is expected that the fabrication is simplified and the performance is improved. In addition, the new design imposes less restriction on the position of each component, compared to the integrated type, and makes it easier to change their forms and layouts. It is possible to improve the frequency characteristic that is dependent on the structure. By separating a heater and a thermocouple, which are key components of the thermal converter, the substrate etching process is eliminated and the stress-induced problems, such

as the heater film delamination from the substrate and change of its characteristics are resolved. The fabrication process is significantly simplified, which is expected to lead to the yield improvement.

As for the materials of a heater and a thermocouple, Ni-Cr alloy and Bi-Sb are selected because they are the proven techniques for our research group. With respect to the heater resistor, we started with improvement of its temperature coefficient since one of primary causes of the AD-DC transfer difference is fluctuation of resistance along with temperature change which occurs when the temperature coefficient is too high. The resistance temperature coefficient of the Ni-Cr thin film before annealing is approximately 100 ppm/K, but when the Ni-Cr thin film is annealed, it can be reduced to as low as ± 25 ppm/K. Annealing in nitrogen ambience is found effective to further reduce the temperature coefficient of the resistor to 10 ppm/K or below. It is assumed that in nitrogen atmosphere, it is heated by thermal conduction through contact with gas, resulting in higher uniformity in heat treatment, enabling strict control over the target annealing temperature. In our fabrication method of heater films, multiple substrates can be used simultaneously in a single vapor deposition process, which makes it possible to fabricate heaters in larger volume than the conventional thermal converter fabrication process.

Fabrication of thermocouple films is basically the same as the fabrication of the conventional thin-film thermal converter. The resistance of the conventional-type thermocouple, however, is as high as several kilo-ohms since approximately 100 pairs of thermocouples are connected in series. In order to improve the resistance, the structure of the thermocouple is changed as shown in Fig. 10. By inserting the Cu film between the Bi film and the Sb film, the contact resistance becomes considerably lower. We have succeeded in reducing the resistance from 4 k Ω to 400 Ω by reducing the contact resistance. We also attempted to increase the output voltage by fabricating thermocouple films on both sides of a substrate. To realize this structure, the following eight evaporation processes need to be performed to deposit thermocouple films on polyimide film by using the mask deposition technique: (1) the Bi film deposition, (2) the Sb film deposition, (3) fabrication of the thin Cu film for an electrode and (4) deposition of the Cu film between Bi and Sb films, and then the same four steps are performed on the other side of the substrate. The vapor

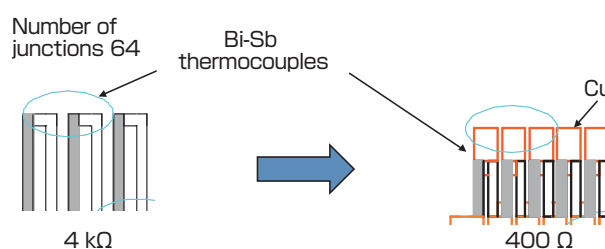

Fig. 10 Improvement of the thermocouple structure

deposition holder shown in Fig. 11 has been developed to fabricate multiple thermocouples at a time even in the complex thermocouple film fabrication process. This holder is effective in positioning the thermocouple film accurately and improving the yield, by which the fabrication method to realize high-volume production is established.

Figure 12 shows the structure of the thin-film thermal converter which we developed this time. The heater resistor and the thermocouple are fabricated separately as described above. The heater resistor and the thermocouple film that satisfy relevant specifications are selected to build a thermal converter. The 12 μm -thick polyimide film on which the thermocouple film is formed is supported by the alumina frame. The aluminum nitride chip on which the heater film is formed is mounted on the polyimide film by using the flip-chip bonding method. Since annealing of heater resistors can be performed independently as described above, the heater resistor is annealed before it is mounted on the polyimide film, which protects other components including electrodes and thermocouples from thermal effects. Thanks to this process recipe, it is now possible to apply the optimal annealing condition and the fabrication is simplified. The thermal converter fabrication is completed when the alumina frame on which the heater resistor and the thermocouple are mounted is covered with alumina. The size of the device

is 2×1.5 cm, and it can be embedded into a measuring instrument.

Next, the improvement in performance is discussed. Since the structure and characteristics of the thermal converter are closely related, the structure is designed in a way to solve the technical issues presented in Subchapter 5.1. For the heater substrate, an aluminum nitride substrate with high thermal conductivity is adopted to prevent degradation and destruction of heater wires due to overcurrent. The AlN substrate also acts as a cooling heat-sink to release heat from the heater resistor, which improves durability significantly, compared to the thermally-insulated vacuum-sealed heater structure. It also becomes possible to expand the current range. In the case of this structure, the DC voltage and the AC voltage are compared not by directly measuring the temperature of the heater wire but by measuring the temperature rise on the aluminum nitride substrate. This structure allows for the thermal converter featuring the rated current of 200 mA.^[22]

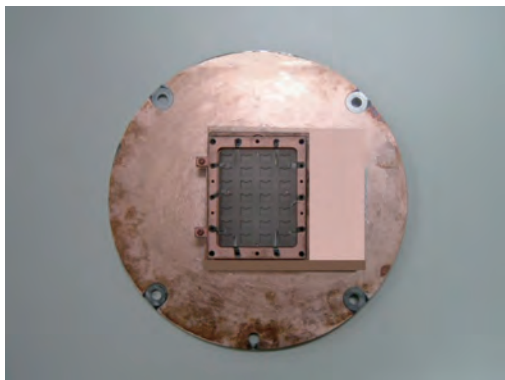

Fig. 11 A rectangle vapor deposition holder for fabrication of thermocouple films

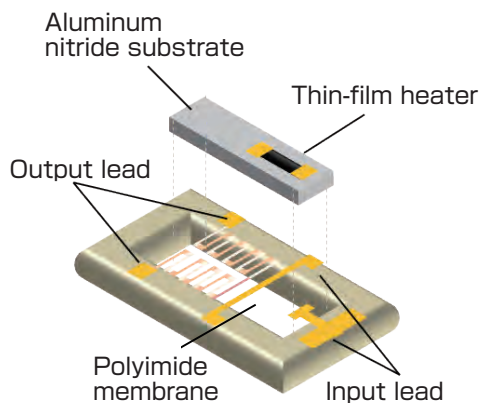

Fig. 12 Schematic diagram of a thin-film thermal converter

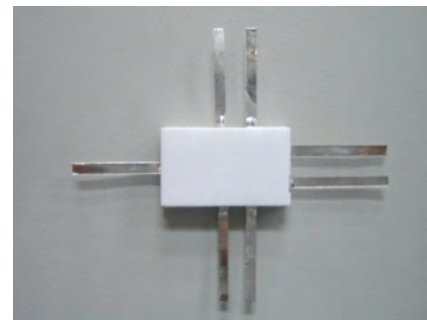
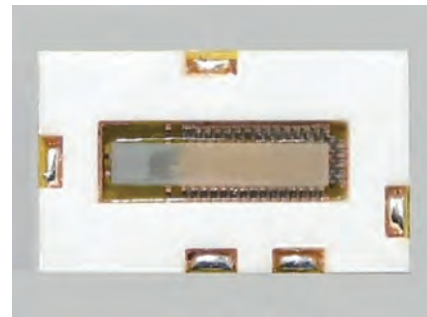

Fig. 13 Inside of a thin-film thermal converter device (top), appearance of a thin-film thermal converter device (middle) and a metal housing for a thermal converter (bottom)

The heater resistance can be changed more easily by adjusting the heater shape and the sheet resistance, compared with the conventional thermal converter. The heater length can be changed in the range of 0.1 mm to several millimeters. A desired resistance can be achieved by monitoring resistance during the formation of the heater film. The heater resistance value can be selected in the range of 1 Ω to 2 k Ω . For a thermal converter with 2 k Ω resistance, voltage of up to 20 V can be applied without using a range resistor which divides voltage for expansion of voltage. Any desired heater shape can be selected, such as the straight type which allows for calculation of the frequency characteristics and the U-shape type which can reduce thermal AC-DC transfer difference. In addition to selection of different resistance values, it is also possible to estimate AC-DC transfer difference by fabricating multiple thermal converters with different frequency characteristics.

The position of the thermocouple is changed from the conventional structure shown in Fig. 5, where it is located near the heater wire, to the position away from the input high side of the heater wire in order to reduce effects of stray capacitance between the heater wire and the thermocouple. By placing the thermocouple on the low side of the heater wire, the potential difference becomes smaller and the leakage current is reduced. The heater film occupies only a limited part of the aluminum nitride substrate as shown in Fig. 14, and the thermocouple detects temperature rise of the rest of the substrate. In the conventional thin-film thermal converter, since the area around the heater wire is thermally insulated, the heater and the thermocouple cannot be located away from each other.

Next a thermal time constant of the thermal converter is designed to improve the AC-DC transfer difference in the low frequency region. A thermal time constant is a value that represents the response characteristics of the output voltage of a thin-film thermal converter and it is also a parameter that determines the frequency characteristics of the thermal ripple in the low frequency region. In the case of the AC-DC transfer difference of the thermal converter, when the input voltage frequency f becomes lower, Joule heat generated in the heater wire oscillates between 0 to the maximum power

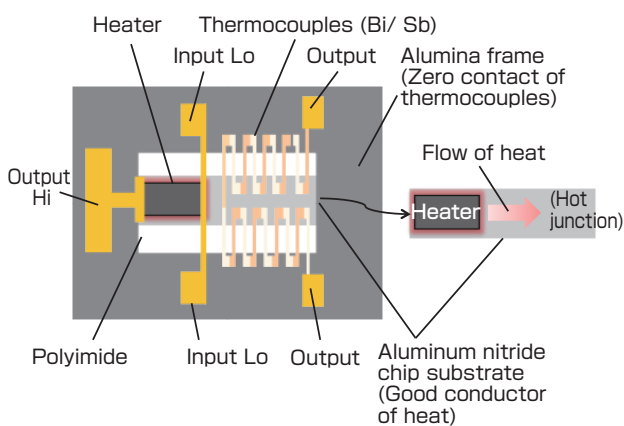

Fig. 14 Layout of a thin-film thermal converter

at a double frequency $2f$. When the input frequency f is not high enough compared to a reciprocal ($1/\tau$) of a thermal time constant of the heater wire, the oscillation of a double frequency $2f$ also occurs for temperature of the heater. A time constant of a single junction thermal converter is around 0.1 s to 1 s, and an effect of the thermal ripple cannot be ignored in the low frequency region of 100 Hz or below. A thermal time constant of the thin-film thermal converter that we developed can be adjusted from 0.3 seconds to 4 seconds by changing the size of the aluminum nitride substrate. For example, the size of the substrate is 0.3 mm \times 1.5 mm \times 8 mm when the time constant is 2 seconds. The thermal time constant of the conventional thermal converter is closely related to its structure and it is difficult to change the thermal time constant independently. The new thermal converter is designed to change the thermal time constant without changing its structure significantly. Along with the improvement in the temperature coefficient of resistance of the heater wire, it becomes possible to improve the frequency characteristics of the AC-DC transfer difference of the thermal converter.

6 Characterization of the thin-film thermal converter

With respect to the performance of the developed thermal converter, the goal of this study is to improve durability and increase usability while keeping its performance high enough to be employed in the national standard instruments. This performance improvement is expected to facilitate a wide use of the new thermal converter in industry. In this chapter, we will describe the characterization of the newly-developed thin-film thermal converter.^[23]

Firstly, a thermal converter of the same structure as the conventional thin-film type was built as a prototype to evaluate its characteristics (Fig. 15). As shown in Fig. 15, the heater film and the thermocouple film were fabricated on a polyimide film instead of a silicon substrate. The thermocouple is located along the heater wire. The frequency characteristics of the

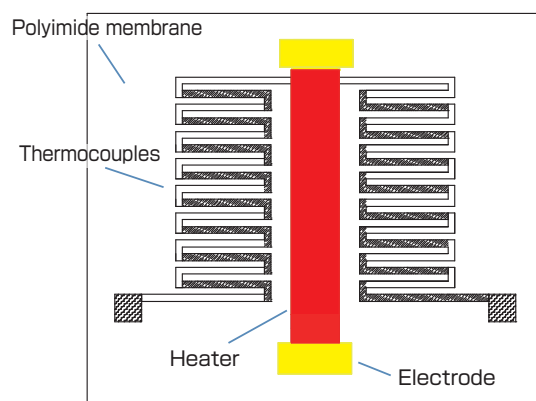

Fig. 15 Schematic diagram of a prototype of a thin-film thermal converter

AC-DC transfer difference of the prototype are shown in Fig. 16. The AC-DC transfer difference at around 1 kHz is approximately 5 ppm and it fails to satisfy Technical Issue (3) listed in Table 1. To be used as the national standard instruments, the thermal converter aims at achieving the AC-DC transfer difference of 1 ppm or below at the frequency of around 1 kHz. The failure to meet this aim is considered to be attributed to non-uniformity of the heat distribution of the polyimide film heater wire induced by the variance of heat inflow/outflow on the heater wire. At the frequency of 1 MHz, the AC-DC transfer difference of 10 ppm or more is observed. This is because the structure of the prototype does not take into account the frequency characteristics of the AC-DC transfer.

Next, the characteristics of the new thermal converter (Fig. 10) are reported. Figure 17 shows the measurement results of the AC-DC transfer difference of the thermal converter at the frequency of 10 Hz to 1 MHz. The dotted line in the figure represents the results of the conventional thermal converter, and the solid line represents those of the newly-developed thermal converter. Through the improvement in non-uniformity of the heater, the AC-DC transfer difference at around 1 kHz has been improved to 1 ppm or below. In order to evaluate the frequency characteristics of the AC-DC transfer difference, the model calculation of the frequency characteristics of the AC-DC transfer difference is performed with the resistance and stray capacitance taken into account. By fabricating the thermal converter shape in a way to strictly meet the design specifications, the AC-DC transfer difference of 10 ppm or below is achieved even at 1 MHz, which is totally different from the result shown in Fig. 16. With our new thermal converter, it is possible to freely change thermal time constant, resistance, shape or layout of the heater, all of which are the causes of the low frequency characteristics of the AC-DC transfer difference listed in Technical Issue (5) in Table 1. The size of the aluminum nitride substrate is adjusted to make the thermal time constant appropriate and the temperature coefficient of resistance is improved to 5 ppm/K or below. By taking these

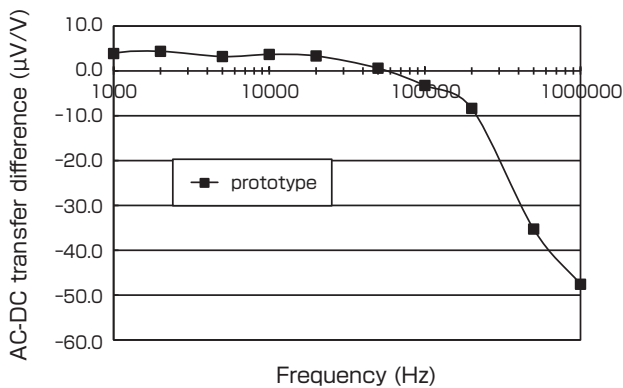

Fig. 16 Frequency characteristics of the AC-DC transfer difference of the prototype thin-film thermal converter

measures, it becomes possible now to fabricate the thermal converter whose AC-DC transfer difference is reduced to 10 ppm or below in a wide frequency range of 10 Hz to 1 MHz as shown with the solid line in Fig. 17. The values of AC-DC transfer differences for the conventional thermal converter were more than 10 ppm at low-frequency and high frequency ranges as shown with the dotted line in Fig. 17. Uncertainty of the AC-DC transfer difference of around 0.1 % is often acceptable in the industrial operations. By using our newly-developed thermal converter, the value of the AC-DC transfer difference can be deemed as 0, which means that Technical Issue (7) in Table 1 is solved.

Figure 18^[23] shows the evaluation of Technical Issue (1) “High frequency characteristics of the AC-DC transfer difference” in Table 1. Figure 18 (a) shows the frequency characteristic of the prototype illustrated in Fig. 15, i.e. the conventional thermal converter in which the thermocouple is located along the heater wire. The open squares represent the measurement results obtained when a low-pass filter is inserted in the thermocouple output circuit while the solid circles represent the results obtained without using a low-pass filter. The difference of the two sets of measurement results suggests insufficient electrical insulation between the heater and the thermocouple. The AC-DC transfer difference constitutes a major source of uncertainty as it depends on the measurement circuit of the thermocouple. It needs to be evaluated, therefore, when a calibration laboratory uses the conventional thermal converter. Figure 18 (b) shows the results of the developed thermal converter. The same frequency characteristic is observed for both cases: with and without the low-pass filter. At the high frequency of 1 MHz, the difference between the two cases is within the range of variance of measured values. The results are good and comparable with those obtained with the thermal converter in which the thermocouple is moved near a zero potential electrode. The usability for calibration laboratories is improved.

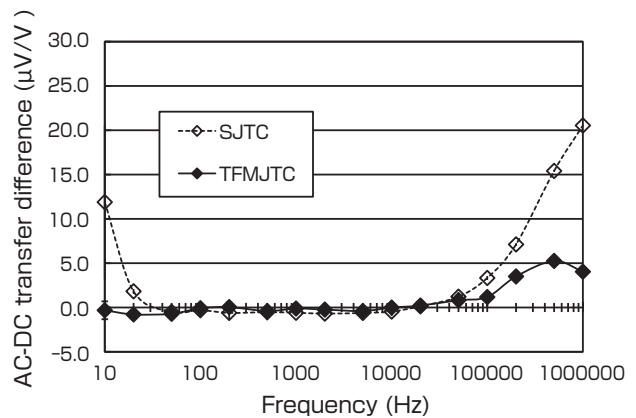

Fig. 17 Frequency characteristics of the AC-DC transfer difference of a single-junction thermal converter (SJTC) and a thin-film thermal converter (TFMJTC)

A thermal converter for high frequency is an example of the thermal converters for which the durability is improved. For the AC voltage standards of 1 MHz or above, for which the effect of impedance matching needs to be considered, it is desirable that a standard is calibrated by a 50 Ω thermal converter. Since the rated voltage of the conventional thermal converter is not sufficient, i.e., 0.5 V, thermal converters other than 50 Ω thermal converters are used for calibration. The voltage range of the newly-developed thermal converter is widened by five times from the rated voltage of the conventional thermal converter, owing to the adoption of the aluminum nitride substrate that releases heat of the heater. Figure 19^[24] shows the voltage dependence of the AC-DC transfer difference of the thermal converter, whose heater resistance is 50 Ω, at the frequency ranging from 1 MHz to 100 MHz. As shown in the figure, the voltage dependence is very small. This thermal converter would not be broken even if 0.5 A voltage is applied in a short time period. This proves that the durability is significantly improved.

In the calibration rooms, the environment conditions including

temperature and humidity are controlled appropriately. In the industrial operations, however, the temperature and humidity may not be kept sufficiently stable. In order to evaluate environmental resistance of the newly-developed thermal converter, the AC-DC transfer difference is measured in various temperature and humidity conditions. Figure 20 shows the results of measurement obtained when the temperature is varied in accordance with the IEC standards. The AC-DC transfer difference of the thin-film thermal converter remains unchanged within the range of detection sensitivity when the temperature is varied. The same measurement is performed at the ambient temperature of 15 °C. It is found that temperature dependence of the AC-DC transfer difference at the temperature between 15 °C to 35 °C is 1 ppm or below.^[25] In order to demonstrate the stability against the humidity fluctuation, the humidity characteristics are evaluated in accordance with the IEC standards. Figure 21^[25] shows the humidity characteristics evaluated and the relative humidity measured in the humidistat bath. The rate of change of the AC-DC transfer difference in the humidity test is 1 ppm or below as shown in Fig. 21. Based on the results, it is considered that the thin-film thermal converter

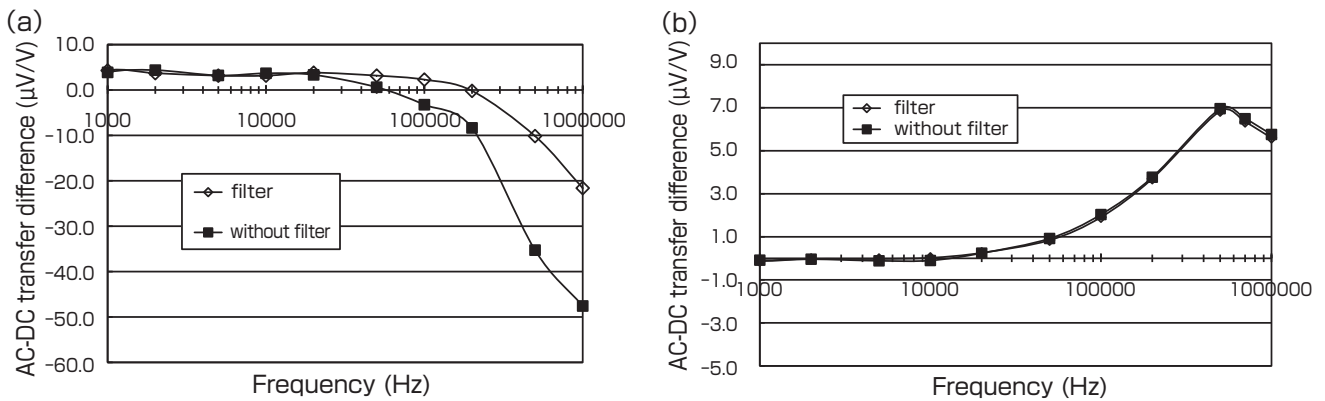

Fig. 18 High frequency characteristics of a multi-junction thermal converter

With a low-pass filter used (◆) and without a low-pass filter used (■) in the thermocouple output

(a) Measurement results for a conventional thermal converter in which thermocouples are located along the heater line

(b) Measurement results for the new thin-film thermal converter

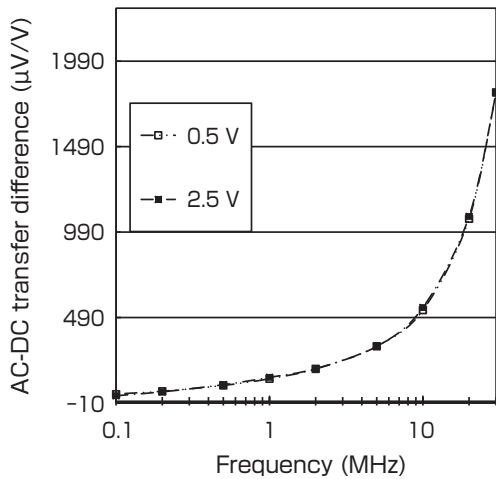

Fig. 19 Voltage dependence of a thin-film thermal converter with a heater resistance of 50 Ω

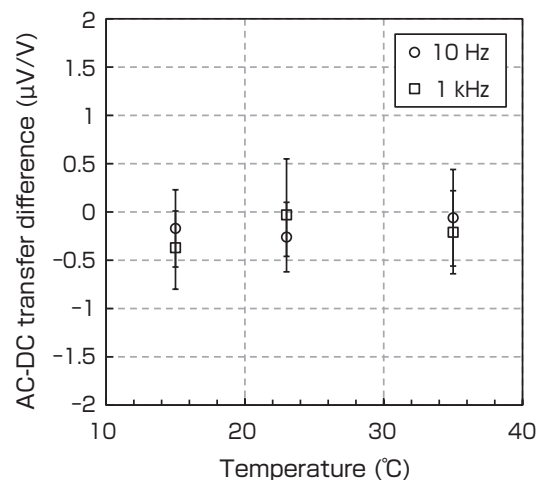

Fig. 20 Temperature characteristics of a thin-film thermal converter

Table 2. Comparison of the thermal converters

AC-DC converter	Single junction thermal converter	Thin-film multi-junction thermal converter	New thin-film multi-junction thermal converter
Fabrication method	Fabricated one by one manually	Microfabrication	Microfabrication
Structure	A heater and thermocouples are vacuum-sealed in a glass in three dimensions.	A heater and thermocouples are mounted on the same substrate	A heater and thermocouples can be fabricated independently on separate substrates
[Features]			
Heater resistance	25 Ω , 90 Ω	90 Ω	1 to 2000 Ω
Rated current	10 mA	10 mA	200 mA
Number of thermocouples	1 pair	100 pairs	68 pairs
Resistance of thermocouples	8 Ω	10 kΩ	400 Ω
Output voltage	7 mV	80 mV	35 mV
Time constant	0.3 s	2 s	2 s
Temperature coefficient of heater resistance	10 ppm	10 ppm	5 ppm
Insulation resistance between heater and thermocouples @ 1 MHz	High	Low	High
Low frequency characteristics @ 10 Hz	Up to 10 ppm	< 1 ppm	< 1 ppm
Thermal AC-DC transfer difference	Up to 1 ppm	Up to 0.1 ppm	Up to 0.1 ppm
High frequency characteristics @ 1 MHz	> 10 ppm	> 10 ppm	< 10 ppm

is sufficiently stable against humidity fluctuation. As described in Reference 25, the newly-developed thermal converter remains very stable over time just like the conventional thermal converter. The new thermal converter is found suitable for industrial applications.

The comparison of the performance between the conventional thermal converter and the developed thermal converter is summarized in Table 2.

7 Future development and challenges of the AC voltage standard

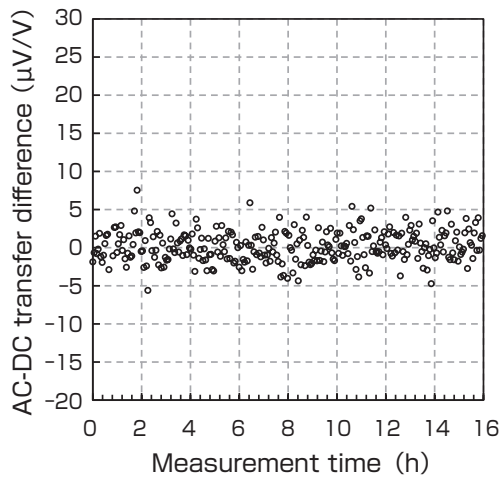

Fig. 21 Humidity characteristics of a thin-film thermal converter

The developed thermal converter is currently put into production at Nikkohm Co., Ltd. About 100 units are purchased annually and used by metrology institutes and/or calibration laboratories in 10 or more countries. The properties of thermal converters including conventional thermal converters are listed in Table 2. Our thermal converter is robust and durable since the rated current of the heater is improved dramatically. Meanwhile, bismuth and antimony are used for the thermocouple film and the melting point of bismuth is as low as 271.3 °C. Although the heater wire is improved so that large current can be applied, the result of the accelerated test shows that the thermocouple will be degraded after use over a long period of time.^[26] At around 20 mA, the effect of heat generated by the heater is small and the thermal converter can be used continuously for at least 20 years. When larger current flows, however, the lifetime of the thermal converter will be 10 years or shorter due to degradation of the thermocouple. In the future, we will be working on improvement of the thermocouple so as to make the best use of the newly-developed thermal converter's characteristic, namely high tolerance to large current.

Although there is a demand from industry for the AC voltage standard in the low frequency region, the lowest frequency of the currently-available AC voltage standard is 4 Hz. In order to expand the range down to 0.1 Hz in the future, we are analyzing the thermal model of the developed thermal converter. A vacuum-sealed thermal converter is now under development, and we are to improve the low frequency characteristics further to expand the range.^[27]

With respect to the future application of the thermal converter, National Metrology Institute of Australia is trying to apply our thermal converter not to the voltage standard but to the power standard.^[28] The AC power standard is derived quantity composed of voltage, current and phase, but the power standard proposed by Australia is to be established based on the thermal converters. We are planning to improve uncertainties of the national primary standard^{Term 2} by using the developed thermal converter in collaboration with Japan Electric Meters Inspection Cooperation, the Designated Institute (DI) which has established the power standard at commercial frequencies in Japan.

Another potential application of the thermal converter is development of a measuring instrument shown in Fig. 22 in which a variety of small detachable transfer standards are embedded. Since the thin-film thermal converter has realized downsizing and improved durability, it may be possibly used as the reference device for AC voltage measuring instruments. It will become possible to use high-precision AC voltage if the stable thermal converter is used as a reference for AC voltage values and the function to feedback the AC voltage output to the thermal converter is developed. By inserting multiple thermal converters, it also becomes possible to check the output values of a measuring instrument shown in Fig. 22. Development of such measuring instrument with built-in detachable transfer standards may lead to reduction of burdens to ensure traceability in the industrial operations. In general, calibration laboratories need to establish traceability for a variety of electrical standards such as DC voltage, DC current, AC voltage and current, resistance and so on. By removing one detachable transfer standard inserted in a measuring instrument and calibrating a single electrical quantity, there is no need to carry the whole measuring instrument. Thus, the calibration can be performed without affecting measurement of other quantities of electricity. By using this approach of calibration, we will promote use of the electricity standards with higher precision.

Acknowledgements

We would like to express our sincere gratitude to all those

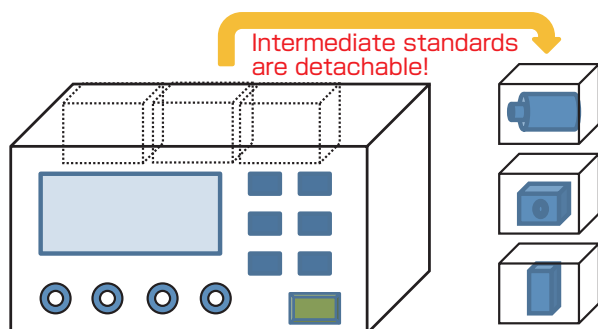

Fig. 22 Development of a measuring instrument in which detachable transfer standards are embedded

at Nikkohm Co., Ltd. for their outstanding contribution to productization based on our study.

Terminologies

- Term 1. Upper-tier reference standard : The traceability system is formed as a hierarchical framework covering the national metrology institute to industrial operations. The system consists of the national standards (primary standards) at the top, the secondary standards owned by the calibration laboratories that are calibrated by the national standards, the working standards owned by the calibration laboratories that are calibrated by the secondary standards and the measuring instruments owned by general users in industry that are calibrated by the working standards. The reference standard with which the reference value is provided is called “the upper-tier reference standard.”
- Term 2. National primary standard : The reference standards that are stipulated in the Measurement Act in Japan are called “the national primary standards.” Standards calibrated by the national primary standards are called “secondary standards” in the framework of the Measurement Act in Japan.

References

- [1] B. D. Inglis: Standards for AC-DC transfer, *Metrologia*, 29 (2), 191-199 (1992).
- [2] F. L. Hermach: Thermal converters as AC-DC transfer standards for current and voltage measurements at audio-frequencies, *J. Res. Nat. Bur. Stand.*, 48 (2), 121-138 (1952).
- [3] M. Klonz and T. Weimann: Accurate thin film multijunction thermal converter on a silicon chip, *IEEE Trans. Instrum. Meas.*, 38 (2), 335-337 (1989).
- [4] B. D. Inglis: A method for the determination of AC-DC transfer errors in thermoelements, *IEEE Trans. Instrum. Meas.*, 27 (4), 440-444 (1978).
- [5] H. Sasaki and K. Takahashi: Development of a high-precision AC-DC transfer standard using the FAST-Reversed DC method, *Researches of the Electrotechnical Laboratory*, No. 989, (1999).
- [6] C. J. van Mullem, W. J. G. D. Janssen and J. P. M. de Vreede: Evaluation of the calculable high frequency AC-DC standard, *IEEE Trans. Instrum. Meas.*, 46 (2), 361-364 (1997).
- [7] H. Laiz, M. Klonz, E. Kessler, M. Kampik and R. Lapuh: Low-frequency AC-DC voltage transfer standards with new high-sensitivity and low-power-coefficient thin-film multijunction thermal converters, *IEEE Trans. Instrum. Meas.*, 52 (2), 350-354 (2003).
- [8] F. L. Hermach and E. S. Williams: Thermal converters for audio-frequency voltage measurements of high accuracy, *IEEE Trans. Instrum. Meas.*, 15 (4), 260-268 (1966).
- [9] M. Klonz: AC-DC transfer difference of the PTB multijunction thermal converter in the frequency range from 10 Hz to 100 kHz, *IEEE Trans. Instrum. Meas.*, IM-36 (2), 320-329 (1987).
- [10] H. Dinter, M. Klonz, A. Lerm, F. Volklein and T. Weimann: AC-DC-mV-transfer with highly sensitive thin-film

- multijunction thermal converters, *IEEE Trans. Instrum. Meas.*, 42 (2), 612-614 (1993).
- [11] J. R. Kinard, D. X. Huang and D. B. Novotny: Performance of multilayer thin-film multijunction thermal converters, *IEEE Trans. Instrum. Meas.*, 44 (2), 383-386 (1995).
- [12] D. Matson: Using a linear thermal transfer standard for high-precision AC/DC transfers, *CPEM '90 Conference digest*, 64-65 (1990).
- [13] H. Fujiki: Improvement of the voltage dependence of high-voltage AC-DC transfer differences at NMIJ, *IEEE Trans. Instrum. Meas.*, 57 (9), 1992-1997 (2008).
- [14] R. L. Swerlein: A 10 ppm accurate digital AC measurement algorithm, *Proc. NCSL Workshop and Symp.*, 17-36 (1991).
- [15] P. S. Filipinski, R. F. Clark and D. C. Paulusse: Calorimetric thermal voltage converter as a wideband calculable standard of AC-DC difference, *IEEE Trans. Instrum. Meas.*, 48 (2), 387-390 (1999).
- [16] G. M. Free, T. E. Lipe, J. R. Kinard and J. E. Sims: Characterization of RF-DC transfer difference for thermal voltage converters with built-in tees in the frequency range 1 MHz to 1 GHz, *IEEE Trans. Instrum. Meas.*, 56 (2), 341-345 (2007).
- [17] R. Behr, L. Palafox, G. Ramm, H. Moser and J. Melcher: Direct comparison of Josephson waveforms using an AC quantum voltmeter, *IEEE Trans. Instrum. Meas.*, 56 (2), 235-238 (2008).
- [18] B. N. Taylor and T. J. Witt: New international electrical reference standards based on the Josephson and quantum Hall effect, *Metrologia*, 26 (1), 47-62 (1989).
- [19] M. Maruyama, C. Urano and N. Kaneko: New drive system for programmable Josephson voltage standard using pulse packet bias, *CPEM 2012 Conference digest*, 50-51 (2012).
- [20] I. Budovsky, D. Georgakopoulos, T. Hagen, H. Sasaki, and H. Yamamori: Precision AC-DC difference measurement system based on a programmable Josephson voltage standard, *IEEE Trans. Instrum. Meas.*, 60 (7), 2439-2444 (2011).
- [21] P. S. Filipinski and M. Boecker: Experience with high-output-resistance MJTC AC-DC transfer standards at high frequencies, *IEEE Trans. Instrum. Meas.*, 52 (4), 1314-1319 (2003).
- [22] H. Fujiki: Development of thin-film multijunction thermal current converters with increased rated current, *IEEE Trans. Instrum. Meas.*, 62 (6), 1853-1858 (2013).
- [23] H. Fujiki: New thin-film multijunction thermal converter design for improved high-frequency performance, *IEEE Sensors Journal*, 7 (9), 1243-1247 (2007).
- [24] H. Fujiki: Development of Thin-Film Multijunction Thermal Converters With a Novel Structure, *IEEE Trans. Instrum. Meas.*, 60 (7), 2725-2729 (2011).
- [25] Y. Amagai, H. Fujiki, K. Shimizume and S. Hidaka: Improved stability of thin-film multijunction thermal converter, *Electrical Engineering in Japan*, 188 (1), 18-26 (2014).
- [26] H. Fujiki, Y. Amagai, H. Sasaki, K. Shimizume, K. Kishino and S. Hidaka: Improved performance of a thin-film multijunction thermal converter, *CPEM 2014 Conference digest*, 48-49 (2014).
- [27] Y. Amagai, H. Fujiki, K. Shimizume, K. Kishino and S. Hidaka: Low-frequency characteristics of a thin-film multijunction thermal converter under vacuum, *CPEM 2014 Conference digest*, 50-51 (2014).
- [28] I. Budovsky: AC-DC transfer standard for mains- and audio frequency power, *EURAMET TCEM SC LF meeting*, (2013).

Authors

Hiroyuki FUJIKI

Completed the doctorate course of physics at the Graduate School of Science, Kyushu University, in 1998. Doctor (Science). Worked at Venture Business Laboratory, Kyushu University the same year, then joined Electrotechnical Laboratory, Agency of Industrial Science and Technology, Ministry of International Trade and Industry in 1999.



Became researcher of Electricity and Magnetism Division, National Metrology Institute of Japan, AIST in 2001. From 2012, Section Chief of Applied Electrical Standards Section, Electricity and Magnetism Division. In this paper, was in charge of establishment of the AC-DC transfer standard, promotion of use of the standard provision, and development and evaluation of thin-film thermal converters.

Yasutaka AMAGAI

Completed the master's degree in the Graduate School of Industrial Science and Technology, Tokyo University of Science in 2004. Doctor (Engineering). Worked at TDK Corporation from 2004 and joined AIST in 2009. From 2013, Senior Researcher of Applied Electrical Standards Section, Electricity and Magnetism Division. In this paper, was in charge of evaluation of resistance of thermal converter devices to the environment including temperature, humidity and pressure in accordance with the IEC standards. Currently is engaged in the development of the system that calibrates AC voltage with a high degree of precision by combining expansion to lower frequency, AC-programmable Josephson voltage and thermal converters.



Hitoshi SASAKI

Completed the master's degree in Division of Physics, Graduate School of Science, Hokkaido University in 1979. Doctor (Engineering). Joined Standards and Measurements Division, Electrotechnical Laboratory, Integrated into AIST when reorganized in 2001. Senior Researcher of Nano-electronics Research Institute. In this paper, was in charge of thermal analysis and frequency characteristic analysis of thin-film thermal converters, design of major parts and contributed in practical use. In particular, built the detailed model of thermal conductivity and determined the optimal size in the thermal analysis.



Discussions with Reviewers

1 General Comment

Comment (Mitsuru Tanaka, AIST)

In view of the gist of this paper, the technology, structure, and method are described fully in detail from the societal, industrial, and international perspective of the standard provision system.

In terms of understandability, however, the distinctions

between the intended measures for the national standards and those for the calibration technique in industry are not yet explained clearly enough. It is necessary to give explanation on the measures relevant to these issues.

Answer (Hiroyuki Fujiki)

The goal of this research is to establish the domestic traceability system for the AC voltage standard, and it is required to deal with the national standards and develop the calibration technique in industry to achieve such a goal as you pointed out. We prepared the first draft having employment of the AC quantum standard and the AC-DC transfer standard as the national standards in mind. The AC quantum standard is mainly for the national standards, while the thermal converter takes care of both the national standards and the calibration technique in industry. As a result, their respective issues were mixed in the text. We reviewed the structure of Chapter 4 and revised it to describe the issues on measures for the national standards and for the calibration technique in industry separately in the independent subchapters. We believe that it is now easier to understand that “establishment of the national standards” + “development of new standard instruments” + “development of technique to promote usage” are essential for the establishment of the AC voltage standard system. In addition, with respect to the necessity of development of the thermal converter, we added the description that the thermal converter was required for the expansion of range of the national standards and using the thermal converter as a calibration instrument was useful for the provision of the AC voltage standard instead of using an AC voltmeter as a transfer standard. We also reviewed the description in Table 1 that listed the technical issues so that it is easier to distinguish the required techniques as the national standards and the techniques required for provision of the standards to industry.

2 Setting of the scenario where this thesis should be covered

Comment (Mitsuru Tanaka)

In Chapter 4, the author mentioned in the original version that “The range of the AC-DC transfer standards in Japan is being expanded starting 2001 in order to cover the range of international mutual recognition and requests from the industrial community.” This sentence suggests that the traceability system has not been completely organized by 2015 when this paper is to be printed. Please check if this interpretation is correct.

In Chapter 4 it is written that “The developed thermal converter is currently put into production by Nikkoho Co., Ltd. About 100 units are purchased annually and used by standards organizations in 10 or more countries. For continuous use in the future, we are working on further improvement in performances of the thermal converters.” I’m afraid that the description misleads some readers into believing that standard organizations are not satisfied with the performance. Therefore, why don't you distinguish between the scenario for this research and development and plans for future development?

Answer (Hiroyuki Fujiki)

The author completed updating the Measurement Standards Development Program at NMIJ set in 2001. The calibration services for AC-DC transfer standards provided by NMIJ cover the range international industries required. On the other hand, domestic industries request the extension of the frequency range below 10 Hz, where the AC voltage standard has not been sufficiently provided. So the authors revised the sentence based on your comment.

The biggest feature of our thermal converter is that the rated current increases dramatically compared with a conventional thermal converter. However, heat generation from high current

affects the materials used for the thermocouples, which do not deteriorate by the low heat generated by the conventional heater. The new thermal converter we developed can be fully used as a national standard, however, we have a plan to improve the performance of the thermocouples to take advantage of the high rated current of the heater. The authors revised the section related to this issue to clarify this point.

3 Contents of technological elements for development of thermal converters

Comment (Mitsuru Tanaka)

It is noteworthy that the description of advantages and disadvantages of technological elements for the development of thermal converters are included. However, some of the candidate elemental technologies lack sufficient explanations. I am not denying the ones that you actually adopted as part of the overall configuration method, but it would be appropriate to add more description from the perspective of objectivity.

Answer (Hiroyuki Fujiki)

Detailed descriptions on the wired multi-thermocouple thermal converter and the thermal semiconductor RMS sensor, which are now provided in Chapter 3 as the candidate elemental technologies for development of the thermal converter, were omitted in the initial draft. The goal of this paper is to establish the domestic traceability system for the AC voltage standard, and we aimed to develop a thermal converter that can satisfy both the development of the national standards and technique to promote its usage. Therefore, we only introduced the names of the wired multi-thermocouple thermal converter that is only specialized for the national standard instrument and the thermal semiconductor RMS sensor that is specialized for the calibration instrument for the standard provision, to avoid even more lengthy description. Considering that explanation of each candidate elemental technology can help general readers other than experts understand better, we added the details on the above candidate elemental technologies.

4 Improvement of the description for product realization

Comment (Hiroaki Hatori, AIST)

As a whole, the description from the background to the scenario of the research and development is very thorough (although it seems rather redundant). However, it may be hard to understand for non-expert readers since the part from the actual development to commercialization is somewhat written in an itemized form and the provided technological development elements are relatively many.

Answer (Hiroyuki Fujiki)

With respect to the technical development elements of the thermal converter, we only introduced the technology briefly so that this would not be like a specialized academic paper. As for the commercialization, the conventional thermal converter has not been used widely in the calibration labs that are close to the production sites because mass production is difficult due to high level of difficulties in the fabrication techniques and it is destroyed easily by operation error including overcurrent. We considered that for commercialization, it was important that the thermal converter had the performance that allowed it to be used as the national standard as well as improved durability and usability. In the initial draft, we provided the technological elements that are required for development of the relevant thermal converter in the subchapters of the elemental technologies for development and Table 1, but in retrospect, we realized that the explanation was insufficient in some parts. We reviewed the section regarding the development of the thermal converter and added the explanation of each elemental technology and details on the corresponding

efforts to solve the issues. As for the explanation of each technological element, we revised the text and Table 1 while adding figures and tables based on the questions and comments from reviewers.

5 Efficient arrangement of the contents for technological elements of thermal converters

Comment (Hiroaki Hatori)

The goals, indices, and reasons for the development of the thermal converter are listed in Table 1 for the technological elements. Meanwhile the background of development and the features of the actually developed thin-film thermal converter are described in Chapters 5 and 6 respectively. Thus the technological elements seemed to be scattered over various areas and it may cause confusion for readers. From a synthesiological perspective, it is important to organize and clearly describe the important technological elements that led to commercialization and the background of development. I would suggest summarizing the main points of the actual development and the resulting features in a figure or a table.

Answer (Hiroyuki Fujiki)

Our motive for the development of the thermal converter was the existing state where although a high-performance thermal converter was required for expansion of the provision range of

the national standards for the AC voltage and improvement of uncertainty, it was difficult to acquire a high quality thermal converter. We also considered that a new standard measurement instrument had to be developed for dissemination of the AC voltage standard because different calibration instruments were used for the AC voltage standard and the AC-DC transfer standard. During the development of the thermal converter, its features are determined according to the combination of various elemental technologies. As a result, descriptions of each elemental technology were scattered in the initial draft and the paper was not easy to read for readers other than experts. We reviewed the structure of the text in order to organize the background of development and the major technological elements; we packed the meaning of the development of a new thermal converter in Chapter 4, and moved the elemental technologies which were in Chapter 4 to Chapter 5. With respect to the major technological elements in Table 1, we revised and added to the table and the text so that the details and reasons for development were connected to the background of development. In addition, we prepared Table 2 to enable comparison between the features of the conventional thermal converter and the developed thermal converter, and added the figure numbers that were relevant to the major elemental technologies to Table 1.