

# Synthesiology

English edition

**New research trends in artifactology**

**Mental fatigue measurement as application software on consumer devices**

**Development of evaluation technologies for sedimentary characteristics**

**International standardization of four dimensional radiotherapy system**

**Preparation of superconducting films by metal organic deposition**

*Synthesiology* editorial board

## Highlights of the Papers in *Synthesiology* Volume 7 Issue 4 (Japanese version Nov. 2014)

*Synthesiology* is a journal that describes the goals and social values of the research activities where the results will be utilized in society, the specific scenarios and research procedures, and the processes of synthesis and integration of the elemental technologies. To allow the readers to see the values of the papers in a glance, the highlight points of the papers that are particularly in line with the characteristic of *Synthesiology* were extracted and presented by the Editorial Board.

*Synthesiology* Editorial Board

### **New research trends in artifactology**

#### **– Modeling of individuals and socialization technology –**

Ota (Research into Artifacts, Center for Engineering) *et al.* describes the methodology to establish the research of artifactology. It is interesting that to attain a sustainable, harmonious relationship between artifacts and individual-society-environment, a methodology is developed from the modeling of individuals whose values shift due to the presence of artifacts, and from the achievement of social technology for artifact co-creation that incorporates both the objective identification and solution finding through collaboration among the parties on issues for which the objectives are unclear. The specific examples given are the individual modeling using an experimental economics method and the modeling of a product service system.

### **Mental fatigue measurement as application software on consumer devices**

#### **– Introducing reliable fatigue index to daily life –**

Iwaki (AIST) *et al.* developed a technology that allows the evaluation of fatigue (flicker test) by measuring the perception threshold of visual “flickering.” This was conventionally used only for academic purposes using special equipment, but this new technology allows the use of general-use electronic devices such as smart phones and personal computers on a daily basis. While the flashing frequency is used in the flicker test, it is shown that the test can be done using the flashing contrast. The elemental technologies for the fatigue monitoring system using the general-use electronic devices and their integration scenario are explained.

### **Development of evaluation technologies for sedimentary characteristics**

#### **– Applicability of the technologies to the assessment of methane hydrate sediments –**

In order to use methane hydrate as a new natural gas resource, accurate prediction of the effect of exploration to the surrounding sedimentary strata is necessary from the perspective of social acceptability as well as economy. This paper by Tenma (AIST) is an overview of the development of a sedimentary deformation simulator for a long-term, safe production, the well integrity evaluation based on the simulation, and the system of wide-area sedimentary deformation evaluation technology that were conducted by the “Methane Hydrate Resource R&D Consortium (MH21).”

### **International standardization of four dimensional radiotherapy system**

#### **– Enhancement of effects of irradiation and assurance of safety –**

In radiotherapy, it is necessary to accurately irradiate the necessary level of therapeutic radiation to the tumor position while avoiding exposure of healthy tissues, although the tumors may move due to patient’s respiration. Hirata (Hokkaido University) *et al.* created the standard for technological requirements of safety for the four-dimensional radiotherapy system considering the time change of the three-dimensional position of the affected area. The strategy and result of the international standardization that was promoted by a wide range of stakeholders including the Japanese medical device manufacturers, physicians, medical technicians, researchers, related government bureaucracies, and others are described.

### **Preparation of superconducting films by metal organic deposition**

#### **– Research and development towards a fault current limiter and other electric devices –**

By forming into a thin film, the high-temperature oxide superconductor is a hopeful material in the application to various devices and equipment, as well as use in the transmission lines. Manabe (AIST) *et al.* originally developed the deposition technology for metal oxides by just “coating and firing” the solution on a substrate by a metal organic deposition method. In this paper, focus was placed on the development of a fault current limiter for the application of high-temperature oxide superconductors to electrical devices. The paper gives the details of the research scenario for the selection and integration of the elemental technologies employed for the practical application of the MOD method.

# Synthesiology – English edition Vol.7 No.4 (Mar. 2015)

## Contents

### Highlights of the Papers in *Synthesiology*

#### Research papers

New research trends in artifactology 200 - 209

– *Modeling of individuals and socialization technology* –

--- J. OTA, N. NISHINO, T. HARA and T. FUJITA

Mental fatigue measurement as application software on consumer devices 210 - 217

– *Introducing reliable fatigue index to daily life* –

--- S. IWAKI and N. HARADA

Development of evaluation technologies for sedimentary characteristics 218 - 228

– *Applicability of the technologies to the assessment of methane hydrate sediments* –

--- N. TENMA

International standardization of four dimensional radiotherapy system 229 - 238

– *Enhancement of effects of irradiation and assurance of safety* –

--- Y. HIRATA, N. MIYAMOTO, M. SHIMIZU, M. YOSHIDA, K. HIRAMOTO, Y. ICHIKAWA,  
S. KANEKO, T. SASAGAWA, M. HIRAOKA and H. SHIRATO

Preparation of superconducting films by metal organic deposition 239 - 250

– *Research and development towards a fault current limiter and other electric devices* –

--- T. MANABE, M. SOHMA, I. YAMAGUCHI, H. MATSUI, T. TSUCHIYA and T. KUMAGAI

**Messages from the editorial board** 251

**Editorial policy** 252 - 253

**Instructions for authors** 254 - 255

**Vol.7 table of contents (2014)** 256 - 257

**Letter from the editor** 258

# New research trends in artifactology

## — Modeling of individuals and socialization technology —

Jun OTA<sup>1\*</sup>, Nariaki NISHINO<sup>1,2</sup>, Tatsunori HARA<sup>1</sup> and Toyohisa FUJITA<sup>1,2</sup>

[Translation from *Synthesiology*, Vol.7, No.4, p.211-219 (2014)]

The aim of Research into Artifacts, Center for Engineering (RACE), the University of Tokyo, is to solve problems related to artifactology. The center has now entered its third stage. A new approach in the problem-solving process has been proposed in this paper. The scenario for problem solving starts by establishing a problem using the concept of co-creation. Next, models related to artifacts are constructed by integrating the methods used in experimental economics and techniques of experimental psychology into computational science, data analysis, and simulation technology. Modeling of individuals is realized by focusing on three processes: recognition of individuals, activities of individuals based on recognized results, and value construction of individuals. This proposal of RACE includes the socio-technical viewpoint of multi-stakeholders and the human-centered viewpoint of modeling of individuals. Several new research topics are presented, including a novel modeling methodology for product service systems (PSS).

**Keywords** : artifacts, modeling, individuals, social technology, co-creation

### 1 Introduction: The aims of artifactology

Research into Artifacts, Center for Engineering (RACE), the University of Tokyo, was established in 1992 to deal with the science of artifactology. The center was set up with the aim of engaging in education and research relating to artifactology. The term “artifactology” is discussed in the paper, “The Creation of New Paradigms for Engineering”<sup>[1]</sup> by Hiroyuki Yoshikawa, former president of the University of Tokyo. The paper states firstly that the many difficult problems we face in relation to the environment, wealth and poverty, safety, and health or, in other words, the “modern evils,” as the results of human behavior in pursuit of safety and wealth are utterly unpredictable. It also stresses that existing academic frameworks are formed depending on discipline boundaries and restricted viewpoints, and are a cause of these problems, to say nothing of difficulty in applying them to solve these problems. As a solution, it proposes the academic framework termed “artifactology” as a new academic discipline that studies all that humans create, denies separate sub-disciplines, and takes in all viewpoints. In other words, it is not a conventional deduction-based academic discipline, but a discipline based on abduction to derive hypotheses, laws, and behavior.

This paper first discusses artifactology in relation to its neighboring disciplinary areas, and then proposes new problems and directions as well as a research methodology for future artifactology, as put forward by RACE. It then outlines concrete problems relating to artifactology extracted by center members in line with the created new direction and

methodology.

### 2 Relation between artifactology and other disciplinary areas, new problems in artifactology

#### 2.1 Positioning of artifactology

This subchapter surveys the disciplinary areas related to artifactology. In his book, “The Sciences of the Artificial,”<sup>[2]</sup> Simon attempts to create an academic framework relating to artifacts made by humans, in contrast to the explanation given by the natural sciences. He argues for an academic curriculum that deals with artifacts, from the perspective of evaluating design, searching for alternative solutions, and extensions to design societies including bounded rationality. Ichikawa<sup>[3]</sup> defines science that does not assume backward causality as artificial science, and states that its outcomes are evaluated by humans on their beauty and usefulness. Gibbons *et al.* pursue the changes in knowledge production modes in modern society.<sup>[4]</sup> They term conventional knowledge produced by the internal mechanisms in each of the disciplines as mode 1 (to which general sciences correspond), and knowledge that is produced in transdisciplinary areas that are more open to society as mode 2. On the basis of their classification they consequently discuss the relation between modes 1 and 2. The “Comprehensive Synthetic Engineering” discipline is defined as “an engineering transdisciplinary research area not seen in traditional engineering that relates artifacts designed and manufactured by mobilizing all the engineering frameworks and knowledge.”<sup>[5]</sup> Because of the importance of this, the Science Council of Japan set up the Committee on Comprehensive Synthetic Engineering in

1. Research into Artifacts, Center for Engineering (RACE), the University of Tokyo 5-1-5 Kashiwanoha, Kashiwa 277-8568, Japan \* E-mail: ota@race.u-tokyo.ac.jp, 2. School of Engineering, the University of Tokyo 7-3-1 Hongo, Bunkyo-ku 113-8656, Japan

Original manuscript received December 2, 2013, Revisions received May 12, 2014, Accepted July 4, 2014

2005. Awareness of artifactology issues is therefore shared among many researchers, and it is clear that the importance of a subject-independent transdisciplinary framework continues to be recognized.

“Problem solving” is one of the aspects intimately related to artifactology within this subject-independent discipline. Smith<sup>[6]</sup> divides problem-solving in the wider sense of the word into two approaches, namely problem setting, which comprises problem identification, definition, and structuring, and problem solving in the narrow sense, which consists of diagnosis and alternative solution generation. In many cases, the latter approach obtains a suitable solution through appropriate modeling and optimization methods. Various methods have been proposed for the former approach,<sup>[7]</sup> but overall they are predominantly termed Soft System approaches.<sup>[8]</sup> A typical method is Soft Systems Methodology (SSM).<sup>[9]</sup> This method aims at multiple problem stakeholders agreeing with others, termed accommodations, and, although it proposes a model consisting of seven steps, there is much qualitative discussion. A merging of both approaches is essential to achieving comprehensive problem solving, and although several attempts have been undertaken (e.g., reference [10]), to date no firmly established methodology exists.

Against this background, we wish to take a high-level view of the positioning of artifactology in which RACE is involved. The external report formulated by Science Council of Japan’s “New Academic Framework Committee” in 2003, discusses design science, which is closely linked to artifactology, as follows.<sup>[11][12]</sup>

Taken in a broad sense, the term “design science” is fitting for intellectual activities that are aimed at the “pursuit of things that should exist.” Design science must be a new science that addresses purpose and value head-on. As design is undertaken for the purpose of people, the subject of design science is artifactual systems. A new academic framework is built through a new concept of the “principle of order,” which is common to both the humanities and sciences. The three stages, the “world of materials,” the “world of biology,” and the “world of humans,” correspond to “physical science,” “life science,” and the “humanities/social sciences,” respectively. Subjects in design science are not limited to these respective domains, but it studies “artifactual systems” linked to any of the three aforementioned domains. Design is an exceedingly human activity that accomplishes its purpose by combining unchangeable laws and changeable programs and realizes value, and design science is an “artifactual system science” that provides it with a rational foundation.

In other words, artifactology is an academic framework for the new creation (design) of artifactual systems in a universal

sense, and, in contrast to the aforementioned problem-solving, can be said to place emphasis on creating artifacts.

## **2.2 Disciplines artifactology research has entered and new problems**

Let us now look at the kind of research RACE, which is involved in artifactology, has conducted. The center started Phase I (1992–March 2002) under a three-division system; namely, design science, manufacturing science, and intelligence science. Problem analysis, then generalization were performed for artifactology (setting off the research agenda), and the foundation was laid for a theoretical structure for the hypotheses and discoveries that realize new functions. Dematerialization and breaking of the limitations of specific disciplines were extracted as the mission of artifactology education and research. These activities also underlie the ideas involved in building a new academic field with more possibilities through a unified reconsideration of various existing fields from a perspective of functionality and universality. However, the main outcome in Phase I was the extraction of problems, and it cannot be said to have succeeded in building a methodology to tackle modern evils. Phase II (April 2002–March 2013) therefore began with the objective of applying the outcomes of Phase I to actual problems (study on creation processes). Four fields that needed to be studied in realizing this mission were proposed, and a division set up for each. First, digital value engineering was proposed as a problem and a knowledge representation method in artifactology. Next, the following were positioned as methodologies for dematerialization: life cycle engineering, which deals not with mass production or consumption but with recycling and maintenance; service engineering, which discusses artifacts from the perspective not of the manufacturing of material but of the provision of functionality; and co-creation engineering, which deals with consensus building among individuals and the construction of the associated society, and links the aforementioned life cycle engineering and service engineering from the perspective of transcending the limitations of specific disciplines.<sup>[13][14]</sup> Further, the Value Creation Initiative (Sumitomo Corporation) Division dealing with value, an important concept in artifactology, was in operation from December 2005 until March 2010. The Phase II outcomes were, in the life cycle engineering division, the establishment of an academic discipline that extended the existing life cycle engineering to cover monitoring and maintenance. In the service engineering division, a design theory for services not constrained to material functionality alone was obtained; in the digital value engineering division, new expressions of knowledge and the creation of value was obtained; and in the co-creation engineering division, a problem-solving methodology through co-creation of various acting subjects in various fields was obtained. The co-creation engineering division built the foundation for the integration of the other three research divisions. The Value Creation Initiative

Division dealt with human values, and performed their modeling.

Considering the overall outcomes of Phase II, it can be said to have generated many research outcomes for design science with its focus on the material world, e.g., design of artifacts that take resource constraints and waste into consideration, and technologies for a large-scale complex simulation base. However, the discussion from the perspective of how to ensure the permeation of created artifacts among “diverse, changing humans” and in “diverse, changing societies,” was still insufficient and issues still remained.

### 3 New direction in artifactology

#### 3.1 Proposed new direction

Phase III (April 2013–onwards) is currently in progress at RACE. We considered it necessary, based on the outcomes and limitations of Phase II, to extend the subject of study in Phase III to include the humanities/social sciences, and to aim at building an academic framework for artifactual system science that is more comprehensive; specifically, extending the subject of study from the world of materials to include the world of biology and the world of humans. To this end, we reorganized and formed two divisions that deal intensively with the themes of artifacts, humans, and society from a perspective of strengthening the merger of the existing four divisions, and of promoting interaction between division members. Figure 1 shows the transition of the involvement of RACE in artifactology. It was discussed and created based on information in reference [15]. A structure was decided upon

that consists of two divisions: from a more micro-perspective, the Human-Artifactology Division (division for the study of artifact-human interaction), which deals with the permeation of artifacts among diverse, changing humans and artifact-human interaction; and from a macro-perspective, the Socio-Artifactology Division (division for the study of artifactology within society), which deals with permeation of artifacts into diverse, changing societies and their interaction.

The division for the study of artifact-human interaction studies the relation between humans and artifacts while aiming to solve a variety of social problems. On the basis of value models obtained in Phase II and knowledge gained in service engineering research, it aims at an important issue relating to people, namely, modeling of individuals. That is, modeling of diverse individuals that also includes in its consideration the dynamics of values that change through the existence of artifacts. While dealing with concrete problems such as product service system design and man-machine cooperation systems, we will clarify how artifacts and humans are related from a universal perspective.

The division for the study of artifactology within society studies the relation between society and artifacts while aiming to solve a variety of social problems. On the basis of the concept of life cycle systems and the concept of co-creation obtained in Phase II, it aims at socialization technologies for artifact creation applied to society, and aims to propose a co-creation design methodology for artifactual systems, incorporating objective setting and solution searching for problems the objective of which is

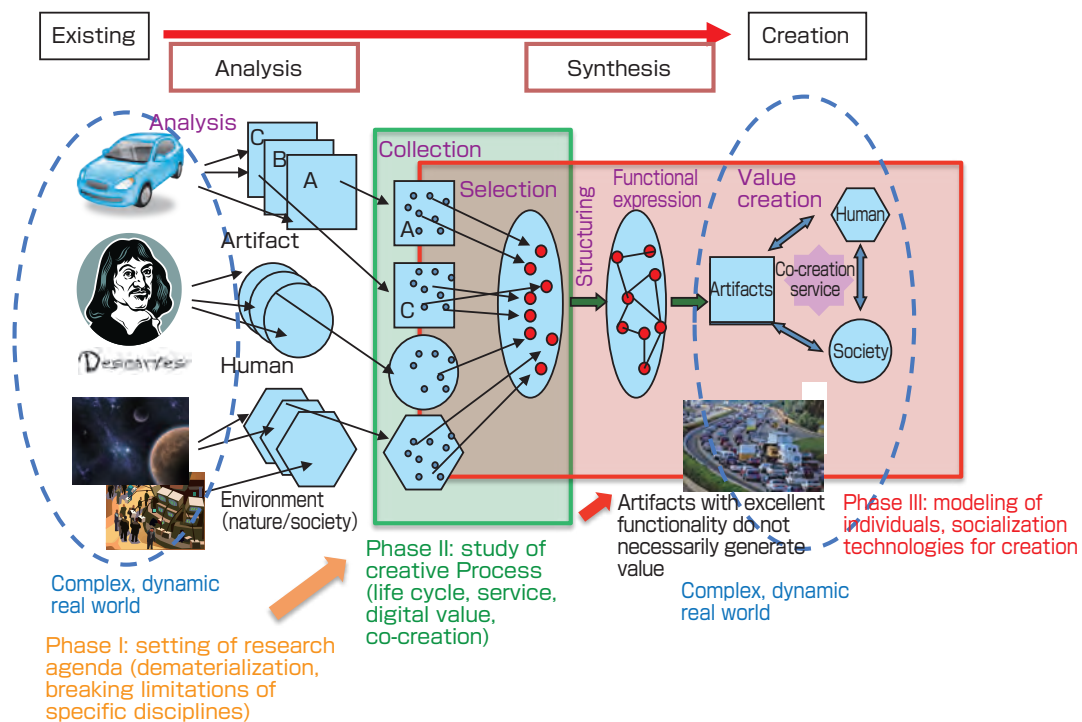

Fig. 1 Transition of the involvement of Research into Artifacts, Center for Engineering, the University of Tokyo, in artifactology.

unknown, through cooperation among stakeholders.<sup>[16]</sup> Here, social technology signifies “technology to build new social systems, integrating knowledge from multiple areas in the natural sciences and humanities/social sciences.”<sup>[17]</sup> While dealing with various problems—e.g., co-creation technology strategies dealing with optimum design in interdisciplinary areas and global environmental problems—affiliated with comprehensive synthetic engineering, in itself active in various academic fields, it will clarify shared structures related to humans and society. Through the cooperation between the aforementioned two divisions, the overall center target is set as “socialization technologies for the creation of artifacts based on the modeling of dynamically changing individuals,” and the aim is to continually construct continuous harmonious relationships between artifacts and individuals/society/environment.

### 3.2 Concrete research methodology

In the previous subchapter, we explained that we will use an approach from the perspective of modeling of individuals and socialization technologies for artifact creation. We now explain this methodology in concrete terms.

Let us first look at “modeling of individuals.” This problem was also dealt with in Phase II, but the main outcome was modeling of individual differences, and hardly any work was done on the changing state, i.e., dynamics, of individuals. In real-world problems, it is normal for actors to gradually change, and this problem is therefore extremely important. The discussion of problem-solving starts from the concept of hierarchical systems. Modeling is performed for humans and artifacts focusing on the complexity of the subject. Describing these as models results broadly in the models shown in Fig. 2. The models consist of elements such as body parts and parts that form humans and artifacts, which in turn combine to form groups, and ultimately society. The individual boxes can be thought of as being formed from two or more levels.

A great deal of modeling has been performed for the respective steps, but modeling that connects the different steps

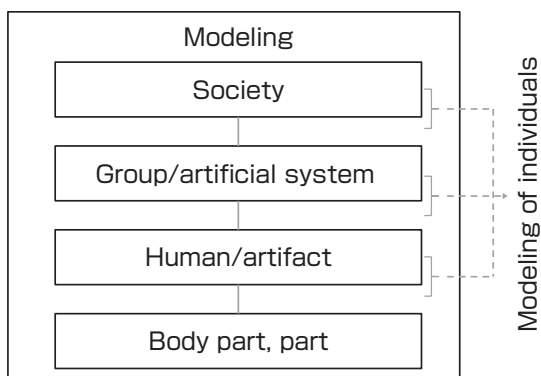

Fig. 2 Overall view of modeling and modeling of individuals

is in general extremely difficult. One reason for this is the fact that the forms of expression vary between models. There is furthermore the discussion that, when the model for one step is homogeneous, the neighboring step characteristically is heterogeneous.<sup>[18]</sup> Although various techniques have been proposed already for the modeling of hierarchical structures,<sup>[19]</sup> there is still room for improvement from the perspective of general knowledge. For simplicity, we will consider the individual in one box to be expressed in the lowest part, and will be modeled in the form of the interaction between the homogeneous elements (each having their internal state, and for this state different values are obtained) in the top part of the box directly below. In this case, the internal state of the elements and the differences in interaction form the diversity of the individuals, and its dynamics form the dynamics of the individual.

Much research has already been done on social technology (e.g., reference [20]), but we deal here with the term “socialization technology” from the problem-solving perspective. There exist various processes for this, but usually the modeling outlined in Fig. 2 is performed and the process progresses based on the derivative analysis, manufacturing, evaluation, and maintenance steps (Fig. 3(a)). Manufacturing in this context has the wider meaning of the introduction into real society of obtained solutions, and is not limited to the making of objects. Artifact creation is also a problem-solving process, and is based on similar processes. However, in this context, it is taken to consider aiming at “socialization technologies” from the preceding step, that is, the problem setting step (Fig. 3(b)). This corresponds to the aforementioned problem-solving in a broad sense, as put forward by Smith.

It is well known that, in the creating of artifacts, it is

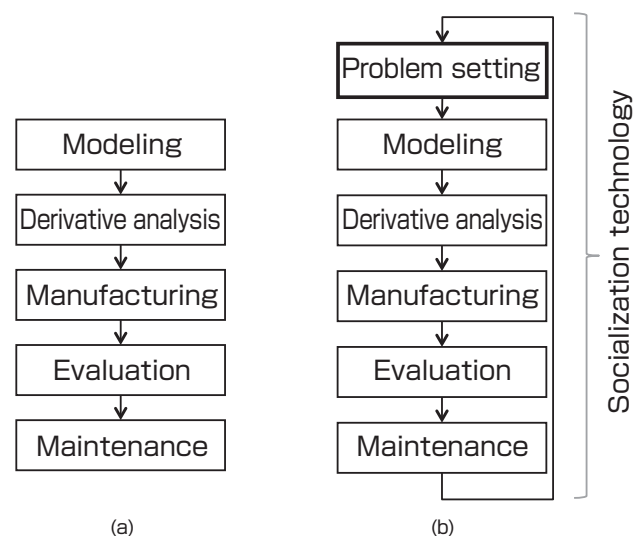

Fig. 3 Artifact design process involving socialization technology: (a) Design process focusing on problem solving in a narrow sense, (b) Design process involving socialization technology

necessary to assume an environment in which there are multiple interested parties whose interests do not necessarily coincide, that is, a multi-stakeholder environment, and the formalization as well as the systemization of the problems in this structure is considered useful in socialization technologies for artifact creation. This problem-solving is intimately linked to class III problems as put forward by Ueda *et al.* According to Ueda *et al.*, problems in the design of artifactual systems can broadly be divided into three classes.<sup>[21]-[23]</sup> Of these, class III problems are explained as “problems with incomplete specification, where not only the environment but also information relating to the objective cannot be predicted by the observer, and are not exhaustively described.”<sup>[7]</sup> Reinterpreted based on this explanation and the discussion of the previous step, this means that this is problem-solving for problems with a vague objective and specification, where the designer and receiver cooperate to simultaneously determine the objective and specification. These problems are extremely burdensome to handle, and were not really tackled head-on in Phase II. Therefore, in Phase III, we aim to deal with these problems as well as the systemization of the problem-solving method, in solving a few real-world social problems.

We wish to outline a scenario for the solving of systems that include these problems.

(1) First, we use data analysis technology, simulations, and computational science as the foundation for our modeling. Many members of our center are specialists in these fields. Additionally, we are considering the inclusion of methods in experimental economics and experimental psychology, which experimentally derive, from an economic and psychological aspect, the behavioral principles and interaction of agents composed of a comparatively small number of acting subjects.

(2) Next, modeling of individuals is performed. The individual is treated as an agent, and modeling is performed from the following three processes: recognition of individuals, activities of individuals based on recognized results, and value construction of individuals, which forms the basis for generating these activities. The aforementioned interaction is expressed in each corresponding step, and facilitates the expressing of interaction and mediation between multi-stakeholders. Such models are linked to each step and aim at modeling society, humans, and artifacts.

(3) On the basis of the modeling formed in (2), problem-solving is performed.

Figure 4 gives an overarching view of this problem-solving scenario. Dynamically changing individuals are modeled using the techniques shown on the left hand side of the image. These contribute to the overall problem-solving

process described on the right hand side, but are mainly made use of in the modeling phase.

This completes the discussion of the framework. Individual applications from various fields need to be applied and described from the perspective of the creation of an academic artifactology framework, and their universality needs to be discussed. We aim for the systemization of academic disciplines that transcend the limitations of specific disciplines, namely, socio technology for problem setting, function theory for modeling, synthesiology for derivative analysis, manufacturing theory for manufacturing, metrology for evaluation, and maintenance theory for maintenance. This is in line with the framework for the design engineering curriculum proposed by Yoshikawa.<sup>[24]</sup>

## 4 Research cases and remaining issues

In this section, we outline some concrete research cases and remaining issues.

### 4.1 Setting collaborative research topics through member collaboration: A product service system modeling scenario

A product service system is “not only for selling products, but also for meeting the needs of users through a combination of product and service.” Using Service Explorer, the world’s first service CAD tool developed by RACE, and by incorporating methodology based on experimental economics techniques, we built an interaction model for designers who design a service, service providers running the service, and service receivers who benefit from the service. We will first explain the general approach of the methodology based on experimental economics techniques, then outline its application to product service systems, and lastly explain the methodology that applies it to the themes concerned.

#### 4.1.1 Application of experimental economics techniques to product service systems

In experimental economics, controlled socioeconomic systems are created in laboratory environments, such as that shown in Fig. 5, where the behavior of actual people

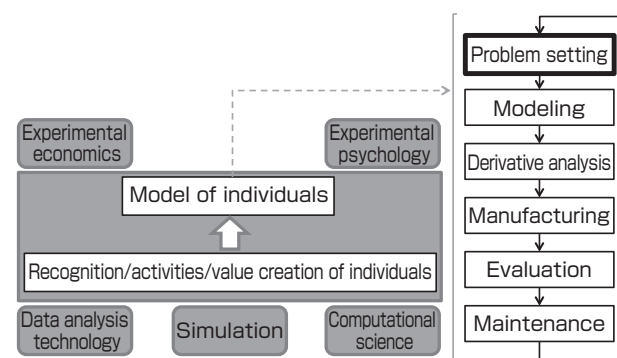

Fig. 4 Problem-solving scenario



as subjects is observed and analyzed. Specifically, based on the induced value theory,<sup>[25]</sup> this is characterized by the controlling of subject preferences through the giving of remuneration (mainly in local currency) for points obtained during the experiment. In other words, the experimenter induces specific utility functions in the subject, observes the behavior within a virtual social system where these utilities are controlled, and by looking at each actor's utility change and overall social surplus, it becomes possible to deal with this explicitly as value. This method enables the modeling of the process of "value construction of individuals" outlined in chapter 2. The techniques for experiments with subjects are the same as the framework for experimental economics thus far, but the novelty lies in developing this, based on the results obtained as actions by real humans, from the level of the individual acting subjects (agents) into a model of the value construction process. It is for this reason that it is necessary to consider in advance, and carefully plan, the framework to conduct an experiment, its behavior patterns, and interaction. Through the combination with the Service Explorer, this has now become possible for the first time. In the case of singular agents, action is based on rationality and is therefore easy to model, but in the case of multiagent systems, the problem of how each agent behaves is inherently difficult owing to the interdependence of all agents' values. A great deal of research has been done that discusses states of static equilibrium such as the Nash equilibrium, but if we include the complex dynamics surrounding this, it is difficult to maintain that we have a sufficient understanding of these particulars. We particularly lack good understanding from the perspective of the construction of value. Techniques centered on experimental economics can contribute to the modeling of this aspect.

Using the aforementioned kinds of methods enables us to verify in economics experiments how a designed product service system functions in a virtual society in a laboratory before applying it in the real world. If an economics experiment reveals that a product service system, however excellent its functionality, does not show sufficient value from the perspective of benefits for a business environment or for consumers, it is clear that it requires either a redesign



**Fig. 5** An actual economics laboratory

of the product service system structure, or a change in the structure of a social system that generates high value; that is, a structural change in the system (mechanism). In this way it would become possible to develop a new artifact design theory.

#### **4.1.2 Modeling a product service system**

Product service system design is not design of the primarily singular artifacts called products, but rather designing the creation of functionality by both products and services, as well as its method of delivery. This necessitates a comprehensive system design that also takes the interaction between humans and society into account. It is essential that there is a modeling of individuals that incorporates mechanisms of purchasing, usage, and participatory behaviors of receivers with bounded rationality, mechanisms that change due to the various interactions within society, e.g., with competitive products or other consumers. We believe that the successive creation and modification of product service systems based on this will be effective.

Figure 6 illustrates the concept of this collaborative research theme applied to the example of a smart house. A smart house is built around physical artifacts, such as a home, electrical appliances, and various pieces of equipment, and allows for the consideration of possibilities in the provision of various services that meet the consumer's needs, through usage expressed by energy supply and demand.

For this concept we first use the Service Explorer to model the receiver, centering on the artifacts, and design the functionality of the product service system (Fig. 6, bottom left).

Next, we refine the model of individuals on aspects of recognition, behavior, and value, using the technique of observation of the receiver's decision-making in the economics experiment outlined in the previous chapter, and modify and refine the product service system (Fig. 6, top left). This means that we perform both function design and design of systems (mechanisms), which takes the interaction of humans and society into account, in the laboratory. We then analyze the systems in more detail using the data obtained through actual service provision as feedback (Fig. 6, bottom right). It is difficult to closely match the items in Fig. 6 with the items in Fig. 4, but broadly speaking, the following correlation can be adduced. "Analysis" corresponds with problem setting and modeling, "function design" and "system design" with derivative analysis, "provision" with manufacturing, and "receipt" with evaluation and maintenance. In other words, this means that modeling of individuals is performed during the problem setting (corresponding to socialization technology) in "analysis" based on the receipt results in the step immediately prior to that. As described above, the outcomes of Phase II can be

used in Fig. 6, bottom left. Figure 6, top left and bottom right are new themes that are dealt with in Phase III.

#### 4.2 Related themes and remaining issues

We have also set other shared themes, some of which are listed below, and aim to achieve the objectives of RACE while solving them:

- New energy policies that take CO<sub>2</sub> emissions, promotion of energy conservation, and stable fuel supply into account.
- New staff education systems—training of industry oriented socialization skills.
- Concept of water demand predictions and emergency water supply systems that take account of citizens returning home at times of earthquakes.
- Nursing techniques self-study support system enabling nursing students to apply the appropriate nursing measures to a variety of patients.

Each of these themes represents typical examples of the “modern evils” outlined at the start of this paper—namely, the environment, wealth and poverty (education is an effective means of solving wealth and poverty problems), safety, and health—and can be said to be typical problems involving both the human aspect of modeling the individual, and the sociotechnological aspect of artifact creation by multi-stakeholders. We expect the solving of these problems to be a major outcome of Phase III.

The most important issue remaining is the problem of transdisciplinary deployment, that is, the question of how to apply a proposed solution for a given problem to other issues. Put in other words, the problem of how to

accumulate knowledge that transcends the limitations of specific disciplines. In the current circumstances we believe that the first step toward solving this problem is to take a comprehensive view of the solution finding process while solving each problem, describe that in as universal a form as possible, and build a database.

### 5 Conclusion

This paper first outlined the current status and future concept of the study of artifactology. It then explained our objective to build continuous harmonious relationships between artifacts and individuals/society/environment, through an approach from the perspective of modeling of individuals and socialization technologies for artifact creation. It also outlined a scenario that applies techniques for modeling individuals with incorporated experimental economics techniques, and extracted the modeling of product service systems as an example theme.

From the perspective of strategic use of its limited human and material resources, Japan needs to concentrate on, and make choices in, both research and education. It is of vital importance that we as researchers not only proactively generate action and behavior in actual society, which also includes social collaboration, but also facilitate structures to promptly circulate any knowledge and information obtained during the process within that organization. The important aspect that must be considered at this time is that introduction of a new evaluation system for research organizations and researchers that incorporates evaluation from the perspective of outcome creation is of the essence. In future, this will require consideration of a new format for evaluating research

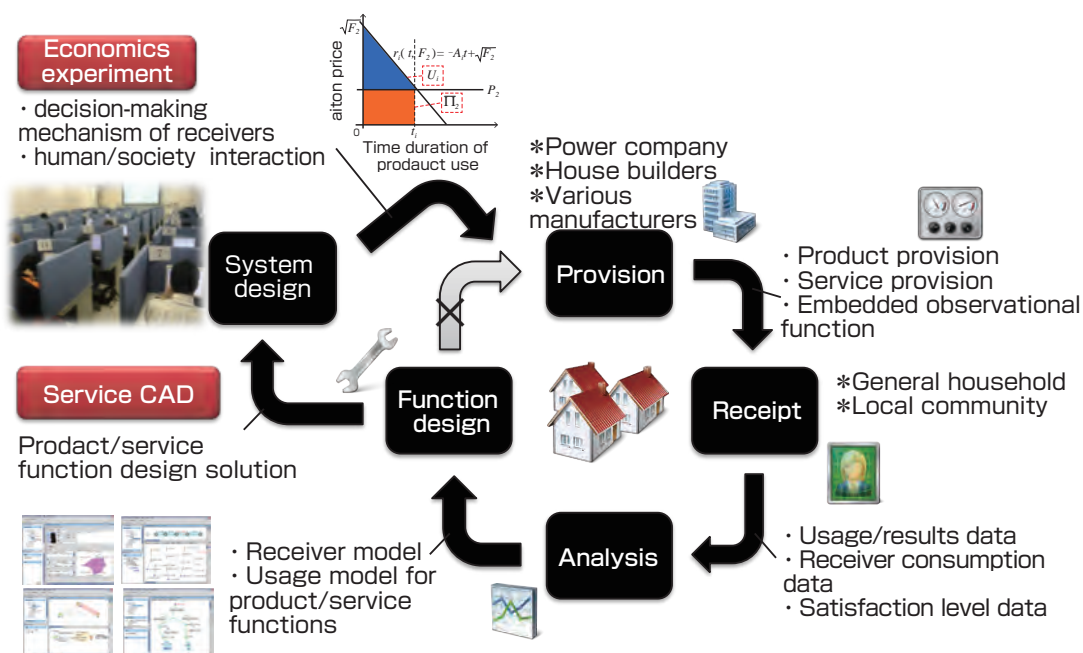

Fig. 6 Product service system concept for a smart house

outcomes.

## Acknowledgements

In writing this paper, we were influenced by various enriching and insightful points of view, for which we are thankful. We would like to express our gratitude to former and present members of the Research into Artifacts, Center for Engineering at the University of Tokyo and other people involved. We also want to express our heartfelt thanks to Professor Emeritus Fumihiko Kimura, the University of Tokyo (presently at Hosei University) and the members of the External Evaluation Committee at the Research into Artifacts, Center for Engineering at the University of Tokyo.

## References

- [1] H. Yoshikawa: The Creation of New Paradigms for Engineering (in Japanese), <http://www.race.u-tokyo.ac.jp/open/documents/Yoshikawa.pdf>, Accessed 2013-07-26.
- [2] H. A. Simon: *The Sciences of the Artificial, third edition*, MIT press (1996).
- [3] A. Ichikawa: Science of artificials and technology, *Journal of the Society of Instrument and Control Engineers*, 42 (3), 165-171 (2003) (in Japanese).
- [4] M. Gibbons, C. Nowotny, H. Limoges, S. Schwartzman, P. Scott and M. Trow: *The New Production of Knowledge -The Dynamics of Science and Research in Contemporary Societies*, Sage (1994).
- [5] Science Council of Japan: Sogo kogaku bunya no tenbo (Prospects of comprehensive engineering) (in Japanese), [www.scj.go.jp/ja/info/kohyo/pdf/kohyo-21-h-3-7.pdf](http://www.scj.go.jp/ja/info/kohyo/pdf/kohyo-21-h-3-7.pdf), Accessed 2013-03-15.
- [6] G. F. Smith: Defining managerial problems: A framework for prescriptive theorizing, *Management Science*, 35 (8), 963-981 (1989).
- [7] M. Tokita: Towards a fundamental theory of managerial problem formulation, *The Waseda Journal of Social Sciences*, 46, 69-95 (1993) (in Japanese).
- [8] K. Kijima: Soft systems approach, *Social and Economic Systems Studies*, 23, 51-65 (2002) (in Japanese).
- [9] P. Checkland, and J. Scholes: *Soft Systems Methodology in Action*, Wiley, West Sussex (1990).
- [10] K. Kijima, M. C. Jackson, K. Kobayashi, T. Negoro, S. Takahashi, H. Chujo and T. Yoshida: *Holistic Creative Management*, Maruzen, (2007) (in Japanese).
- [11] Science Council of Japan: Atarashi gakujuutsu no taikai – Shakai no tame no gakujuutsu to bunri no yugo (Structure of new science – Science for society and integration of separation) (in Japanese), <http://www.scj.go.jp/ja/info/kohyo/18pdf/1829.pdf>, Accessed 2013-07-26.
- [12] Science Council of Japan: Atarashi gakujuutsu no taikai (Structure of new science) (in Japanese), <http://www.scj.go.jp/ja/info/kohyo/pdf/kohyo-18-t995-60-2.pdf>, Accessed 2013-07-26.
- [13] Y. Baba: Jinkobutsu kogaku kenkyu wa nani ga dekinakattaka (What study of artifact engineering could not do) (in Japanese), <http://www.zzz.rcast.u-tokyo.ac.jp/PDF/soukatsu.pdf>, Accessed 2013-02-18.
- [14] T. Fukuhara, T. Takenaka, S. Morishita, M. Suzuki, N. Nishino, N. Fujii and H. Takeda: A study of the value creation of artifacts: a case study in the movie industry, *The 22nd Annual Conference of the Japanese Society for Artificial Intelligence*, 3B3-10, 1-4 (2008) (in Japanese).
- [15] K. Ueda, T. Takenaka and K. Fujita: Toward value co-creation in manufacturing and servicing, *CIRP journal of Manufacturing Science and Technology*, 1(1), 53-58 (2008).
- [16] N. Nishino: Co-creative value manufacturing: a methodology for treating interaction and value amongst artefacts and humans in society, *Nanotechnology Perceptions*, 9 (1), 6-15 (2013).
- [17] Shakaigijutsu no kenkyu kaihatsu no susumekata ni kansuru kenkyukai: Shakai gijutsu no susumekata ni tsuite (How to conduct sociotechnology) (in Japanese), <http://www.ristex.jp/aboutus/pdf/his02.pdf>, Accessed 2014-04-26.
- [18] M. Ito: Jiritsu bunsan shisutemu wa ika ni shite kosei sareruka (How autonomous distributed systems are composed), *J. Soc. Instrum. Contr. Eng.*, 29 (10), 877-881 (1990) (in Japanese).
- [19] H. Sakaguchi, K. Kusano and D. Suetsugu (eds.): *Multi-structure Dynamics*, University of Tokyo Press, (2008) (in Japanese).
- [20] H. Yoshikawa: Interview: Kagaku to shakai gijutsu no mirai (Future of science and sociotechnology), *Sociotechnica*, 1, i-viii (2003) (in Japanese).
- [21] K. Ueda: Jinkobutsu kankyo no seimeiron paradaimu (Paradigm of the theory of life of artifact-based environment), *Gijyutsuchi no Shatei* (The Range of Technological Knowledge), H. Yoshikawa, T. Taura, T. Koyama, K. Ito (eds.), University of Tokyo Press, 129-149 (1997) (in Japanese).
- [22] K. Ueda: Sohatsuteki Sinsesisu no houhouon (Methodology of emergent synthesis), *Report on the Program for the Promotion of Scientific Research with a View to Creating Intellectual Resources*, (2001) (in Japanese).
- [23] K. Ueda, A. Markus, L. Monostori, H. J. J. Kals and T. Arai: Emergent synthesis methodologies for manufacturing, *CIRP Annals - Manufacturing Technology*, 50 (2), 535-551 (2001).
- [24] The Engineering Academy of Japan: *Sekkei gata kogaku no kariyuramu*, EAJ News (in Japanese), <http://www.eaj.or.jp/eajnews/news147/01.html>, Accessed 2013-07-26.
- [25] V. Smith: Experimental economics—induced value theory, *American Economic Review*, 66 (2), 274-279 (1976).

## Authors

### Jun OTA

Received B.E., M.E. and Ph.D degrees from the Faculty of Engineering, the University of Tokyo in 1987, 1989 and 1994 respectively. From 1989 to 1991, joined Nippon Steel Cooperation. Became Research Associate (1991), Lecturer (1994), Associate Professor (1996), the University of Tokyo. From April 2009, Professor, Graduate School of Engineering, the University of Tokyo. From June 2009, Professor, Research into Artifacts, Center for Engineering (RACE), the University of Tokyo. From 1996 to 1997, Visiting Scholar, Stanford University. His research interests are multi-agent robot systems, design support for large-scale production/material handling systems, mobiligence, human behavior analysis and support. He has contributed to constructing generalization of the thesis, and structure of overall/concrete contents.



### Nariaki NISHINO

Received B.E. (1999) and M.E. (2001) in mechanical engineering from Kobe University, received Ph.D. in precision engineering from The University of Tokyo (2004). Postdoctoral fellow (2004-2005), Assistant Professor (2006-2009), Co-creation Engineering Research Division, Research into Artifacts, Center for Engineering (RACE), The University of Tokyo. Currently Associate Professor, Department of Technology Innovation, School of Engineering, the University of Tokyo. He is engaged in studies of artifact design considering aspects of social systems with the method of experimental economics and agent-based simulation. His research interests include game theory, mechanism design, network externality, management of technology, and product service systems. He is also active in collaborative research on decision-making problems with manufacturing and service industries in Japan. In this article, he contributed to a part of the methodology concerning socialization technology and explanation about the concrete theme.



### Tatsunori HARA

Received B.E. (2004) in system innovation, M.E. (2006) and Ph.D (2009) in precision engineering from the University of Tokyo. Assistant Professor (2009-2011), Department of Precision Engineering, School of Engineering, the University of Tokyo. Currently Associate Professor, Human-Artifactology Division, Research into Artifacts, Center for Engineering (RACE), the University of Tokyo. His research interests include serviceology, service engineering, service design, product service systems, and tourism informatics. He has been working on development of a service CAD system called Service Explorer, which is a main deliverable of service engineering division in Phase of RACE. In this article, he contributed to a part of the methodology concerning modeling of individual and explanation about the concrete theme.



### Toyohisa FUJITA

Director of Research into Artifacts, Center for Engineering, also Professor of Department of Systems Innovation, Graduate School of Engineering, the University of Tokyo. Was Professor, Akita University (1995-2003). Was President, Resources Processing Society of Japan, (2005-2009), President, the Research Forum on the Recycling Technology of Rare Metals from 2014. Themes of his research are recycling technology, mineral processing, environmental purification and preparation of intelligent fluids with nanotechnology. Received 30 awards from different kinds of societies. Also he has over 400 publications and submitted over 60 patents. He has contributed to the discussion on the total concept and direction in this paper.



## Discussions with Reviewers

### 1 Overall content

**Comment (Masaaki Mochimaru: Center for Service Research, AIST)**

I understand that this article proposes a research framework centering on the discussion at the Research into Artifacts, Center for Engineering at the University of Tokyo, which performs a central role in the establishment of an artifactology framework and shaping of the methodology and direction in its further development, and outlines some examples of research activity based on this framework. Artifactology and *Synthesiology* share the same root, and the objectives of artifactology match the scope of the *Synthesiology* journal. I therefore think that the discussion of the research framework proposed in this article is useful for the readers of this journal, too.

However, I feel that the present composition does not form a paper on “new issues in artifactology and a new research framework for tackling these,” but rather is “an introduction of Phase III at the Research into Artifacts, Center for Engineering, the University of Tokyo.” As the formation of an “artifactology research framework” is the ultimate target this article must aim for, perhaps you could develop the argument for that.

**Answer (Jun Ota)**

Thank you for your valuable comment. I agree that the paper should be written more from a perspective of the development of artifactology rather than of the Research into Artifacts, Center for Engineering, the University of Tokyo. I have changed the structure in accordance with your suggestion.

### 2 The relation between Phase II and Phase III

**Question (Motoyuki Akamatsu: Human Technology Research Institute, AIST)**

The article explains the two divisions for socio-artifactology and human-artifactology that were established in Phase III, but although it mentions that both are “based on activities in Phase II,” the relation between Phases II and III is not clearly explained. I would like the hypothesis formation process that deemed the initiative necessary to be described, e.g., why were multi-stakeholder problems or problems in searching for a solution where the problem specification is incomplete not handled by life cycle engineering or co-creation engineering; or did it surface as an important issue in the practicing of life cycle engineering and co-creation engineering?

**Answer (Jun Ota)**

Phase II produced many research outcomes for design science based on physical science. In Phase III, we develop this to include the humanities/social sciences as subjects of study and also consider anything involved in human society. Against this background, we discuss socialization technology problems in connection with class III problems, as proposed by Professor Kanji Ueda. This problem was not sufficiently dealt with head-on in Phase II, but as our mission in Phase III is to solve a number of real-world problems and it is extremely important, we aim to deal with this problem and also systemize the problem-solving method. As the link between the outcomes for Phase II and Phase III was unclear, we have rewritten both descriptions to better reflect the difference. For instance, the description has been changed to make the outcome for the Value Creation Initiative Division the human sense of values. A concrete summary of Phase II outcomes has also been added (e.g., design of artifacts that take resource constraints and waste into consideration, and technology for a large-scale complex simulation base).

Regarding modeling of individuals, this was also dealt with in Phase II, but the main outcome was modeling of individual differences. As changes in the state of individuals, i.e., dynamics,

were insufficiently dealt with in Phase II, we consider dealing with them in Phase III. This has been added to the paper.

### 3 Modeling of individuals

#### Comment (Motoyuki Akamatsu)

The article writes about modeling of individuals, but I was unable to grasp what this is based on just the description. Furthermore, the experimental economics approach is given as a case example, and I infer that it is employed as an experimental method to perform modeling of individuals, but no hypothesis is provided on what is a required condition for the modeling of individuals or what kind of functionality is made possible in the experimental system if this condition is met. I think that writing such hypotheses would enable readers to understand it as a concrete approach to achieve the center's mission.

#### Comment (Masaaki Mochimaru)

"Modeling of individuals" is an important term in the research approach in Phase III. However, the reviewer has not been able to form an explicit understanding of this "modeling of individuals."

#### Answer (Jun Ota)

Regarding modeling of individuals, we have firstly amended the description of the hierarchical structure. For simplicity's sake, individuals in one box are considered to be expressed in its lowest part, and these are modeled in the form of interaction between homogeneous elements in the top position of the box immediately below (each having an internal state, and for this state different values can be taken). In this case, the internal state of the elements and the differences in interaction form the diversity of the individuals, and its dynamics form the dynamics of the individual. On that basis, we treat the individuals as agents and perform modeling from the perspective of three processes, namely, recognition of individuals, activities of individuals based on recognized results, and value construction of individuals, which underpins the generation of these activities. The aforementioned interaction is mainly expressed in the steps of recognition of individuals and activities of individuals, and the interaction and mediation among multi-stakeholders can then also be expressed. We have added an explanation to this effect. This is modeling of

individuals.

Regarding the experimental economics approach, modeling is easy in the case of singular agents since behavior is rationality based, but in the case of multi-stakeholder systems, because of the interdependence of each agent's values, how each agent behaves is not well understood. Methods in experimental economics contribute to the model development of that aspect. Through experimental economics the experimenter induces specific utility functions in the subject, observes the behavior within a virtual social system where even utility is controlled, and, by looking at each actor's utility change and overall social surplus, it becomes possible to deal with this explicitly as value. This method enables the modeling of the process of "value construction of individuals" outlined in chapter 2. This has been added to the paper.

### 4 Socialization technology

#### Comment (Motoyuki Akamatsu)

As the initiative in Phase III centers on explaining experimental economics research, I think the approach of research relating to socialization technology has not been emphasized in concrete terms. As this is research that will be conducted from now onward, I do not think it can be easily organized along the lines of the framework, but for the reader to understand this emphasis it is desirable that it is adjusted to the extent that the overall article is organized in a logical manner.

#### Answer (Jun Ota)

As you have pointed out, the paper contained little discussion of socialization technology and we have therefore made an addition to this effect. Multi-stakeholder environments themselves are considered to be strongly linked to socialization technology. We have described the correspondence relation in figures 4 and 6. "Analysis" corresponds to problem setting, "function design" and "system design" to derivative analysis, "provision" to manufacturing, and "receipt" to evaluation and maintenance. This means that modeling of individuals is performed while problem setting (corresponding to socialization technology) is conducted based on the results received in the step immediately prior to "analysis."

# Mental fatigue measurement as application software on consumer devices

— Introducing reliable fatigue index to daily life —

Sunao IWAKI<sup>1\*</sup> and Nobuyoshi HARADA<sup>2</sup>

[Translation from *Synesthesiology*, Vol.7, No.4, p.220-227 (2014)]

Monitoring mental fatigue is critical for traffic safety and health care. Various indexes of mental fatigue have been developed and used in the fields of ergonomics and industrial hygiene. One such index is the flicker-perception frequency threshold: the frequency at which the perception of flickering lights disappears for human observers. This index has a long history as a reliable indicator of mental fatigue in the laboratory setting. We have developed low-cost technologies for measuring mental fatigue objectively with widely available consumer devices such as personal computers and smartphones.

**Keywords :** Mental fatigue, flicker perception threshold, personal mobile device, traffic safety

## 1 Objective of research and background of related technologies

The accumulation of mental fatigue in daily living is not only an issue of health management where overwork may negatively affect health, but also is a serious social and economic issue where such fatigue may link directly to decreased work efficiency or traffic accidents caused by reduced wakefulness. Particularly, drowsy driving and reduced attention due to overwork have been indicated as some of the major factors of serious traffic accidents in commercial vehicles such as freight trucks,<sup>[1]</sup> and the realization of technology that allows evaluation of daily fatigue condition without excessive economic cost has been highly in demand. Therefore, our objective was to quickly develop a technology that allows objective and quantitative monitoring of mental fatigue level at low cost, easily done on a daily basis, using the information device that are commonly available.

Meanwhile, there have been several indices developed for the quantitative evaluation of mental fatigue condition, and these were used mainly for research purposes. The major methods can be listed as follows:

### A. Subjective index

– Self-conscious index:

Subjective symptoms of fatigue (QA sheets and questionnaires)<sup>[2]</sup>

### B. Objective index

– Behavioral index:

For the required task, workload and frequency of error

during work<sup>[3]</sup>

Changes in movement and posture unrelated to required task<sup>[4]</sup>

– Physiological index:

Respiration, pulse rate, sweating,<sup>[5]</sup> Electroencephalography (EEG),<sup>[6]</sup> etc.

– Perception and cognition index:

Flicker perception threshold of visual stimulus<sup>[7]</sup>

Spatial discrimination threshold of tactile stimulus<sup>[8]</sup>

– Biochemical index:

Metabolites in saliva, urine, or blood; genetic expression; etc.<sup>[9]-[11]</sup>

In the measurement of fatigue based on above objective indices, the measurement and analysis of data or samples were conducted using special equipment under supervision of the test administrator, and the data were interpreted as part of the research activity. Therefore, it was impossible for ordinary users to use them readily in their daily lives. For example: (i) for the measurement of behavioral index, the performance evaluation specialized for particular tasks must be conducted, and it is necessary to record the subject's actions from a third-party viewpoint using cameras as well as conduct advanced image processing; (ii) to use the physiological signals such as respiration or pulse rate, a transducer is necessary to convert such signals into digital data that can be handled on portable information terminals; and (iii) to use the biochemical index, it is necessary to have specialized equipment for collecting and analyzing biological samples. Hence, the realization of a system that can be used by general users in the course of their daily lives was difficult. In contrast, for the sensory and cognitive indices,

1. Human Technology Research Institute, AIST Tsukuba Central 6, 1-1-1 Higashi, Tsukuba 305-8566, Japan \* E-mail:s.iwaki@aist.go.jp, 2. Flicker Health Management Corp. AIST Kansai, 1-8-31 Midorigaoka, Ikeda, Osaka 563-8577, Japan

Original manuscript received January 14, 2014, Revisions received June 20, 2014, Accepted August 5, 2014

if there is a presentation of sensory stimuli to evoke visual, auditory, or somatic perception, as well as a way to collect responses from the user, it may be possible to achieve a system using a device to which we have daily access.

## 2 Scenario for realizing a fatigue measurement system that can be used in daily life

We decided to develop a technology that enables the quantitative evaluation of fatigue based on the changes in flicker perception that is presented visually using general-use electronic devices such as smart phones, personal computers, or car navigation systems.

There is a frequency threshold at which “flickering” can be perceived when the frequency of the intermittent point-light stimulus is gradually decreased (this is called the critical fusion frequency or critical flicker frequency, CFF) (Fig. 1). Since it was first reported in 1941 that CFF declined with accumulation of fatigue,<sup>[7]</sup> it became widely known as a quantitative measure for degree of fatigue. Since CFF has the properties that (i) change monotonically in time with continuous workload (that is, accumulation of fatigue), and (ii) are stable with small fluctuations between measurements, it has been used as an important research tool in the field of industrial health, industrial physiology, and traffic psychology (flicker test).<sup>[12][13]</sup> The flicker test is thought to measure the flicker perception threshold that changes according to the excitability of the central nervous system including the brain cortex or the change in the level of arousal due to accumulation of fatigue. Since there are personal differences in CFFs, it is reasonable to measure CFF of the subject at a normal state, and to determine the fatigue condition at a given time based on “how much the measured CFF changed compared to the normal condition.” For example, caution must be issued when CFF is decreased 5 % compared to the normal state, or one must take a break if it decreases 10 % or more. According to the previous research, in the case where CFF decreases 10 % or more, it is known that the cognitive and behavioral performance degrades significantly as represented by the worsening of scores on a simple math test.<sup>[14]</sup>

Major technological issue when conducting the flicker test using personal computers and smartphones is “how to measure the flicker perception threshold using the display

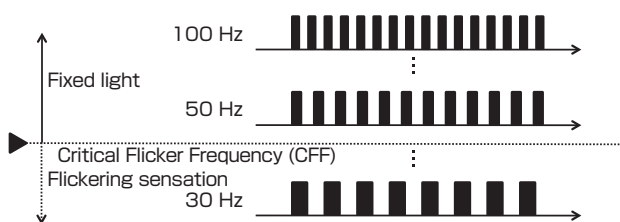

**Fig. 1 Critical flicker frequency (CFF)**

of general-purpose electronic devices.” In the conventional flicker test, LED is used to gradually change the flashing frequency of visual stimulus by 0.1 Hz units to determine the threshold at which the subject perceives the flickering sensation. On the other hand, for the display screen of smartphones or PCs, the vertical synchronizing frequency (refresh rate) is fixed at a certain value (15 or 30 Hz with typical cell phone displays; 60 Hz with PCs), and the flashing frequency cannot be controlled at 0.1 Hz accuracy. Therefore, it is necessary to develop a method to evaluate the flicker perception threshold that is compatible with CFF but not dependent on the changes in the flashing frequency of visual stimulus.

Also, in the conventional flicker test, the method of limit, where the flashing frequency is gradually and continuously changed at certain intervals and the subject is asked to push a button at a point when he/she subjectively perceives the flickering, is used to determine the frequency threshold of the flicker perception. With this method, it is difficult to remove the contamination from habituation and expectation as one takes the flicker test repeatedly, as well as the bias from subject’s arbitrariness or intention to manipulate the results. These issues had not been critical problems in conventional use such as in a laboratory setting where the examiner and the subjects sat face-to-face while collecting the data, and thereby it had been possible to maintain the subject’s motivation for accurate data measurement. However, in the case of measuring the flicker perception threshold autonomously without an examiner in daily life, avoiding the bias from arbitrary operation by the examinee during measurement becomes an issue that must be taken into serious consideration.

We developed techniques to bring the reliable fatigue measurement method based on the flicker perception threshold, which is originally used for academic research in the laboratory setting, to our daily life. We also constructed a prototype system by integrating the elemental technologies, and conducted fatigue evaluation experiments in the real environment to verify the effectiveness of our approach.

## 3 Elemental technologies to realize a simple fatigue measurement system that can be used daily

As mentioned above, to realize the quantitative evaluation of mental fatigue in the daily environment by flicker perception threshold measurement that has been used for research in a lab setting, it is mandatory to solve the following technological issues:

- (a) To develop the elemental technology that allows the measurement of flicker perception threshold, which was measurable only on specialized devices, to be made on

general-purpose display devices.

At the same time, it is necessary to deal with new issues that may arise in the course of transferring the fatigue measurement from laboratory setting to our daily environment. Particularly, the following technology needs to be developed to realize the fatigue measurement in our daily life:

(b) To develop a mechanism that allows users to conduct the test autonomously, that is, to develop the elemental technology that allows the measurement of flicker perception threshold, which was originally dependent on the subjective reporting of the examinee under the supervision of the examiner, in an objective manner even by the user alone.

### 3.1 Measurement of flicker perception threshold using the general-purpose display: Contrast-controlled flicker stimuli (CCFS)

First, we developed a technique to allow the CFF measurement on general-purpose display devices, based on the previous research that there is a systematic relationship between the flicker perception threshold in the flashing frequency and the brightness contrast (a difference in brightness between ON and OFF of the flashing light stimuli).<sup>[15][16]</sup> Figure 2 shows the relationship between the flashing frequency and the brightness contrast at which the observer perceives a flickering sensation (flicker perception threshold: FPT). (edited based on References [15] and [16]). The FPT is affected by changes in both the flashing frequency and the brightness contrast. When the measurement value in normal conditions is the black line, it changes to the grey line in conditions of fatigue (Fig. 2). This means that under the same brightness contrast, flicker is readily perceived as the flashing frequency decreases, and under the same flashing frequency, flickering is readily perceived as the brightness contrast increases. In the conventional flicker test, the frequency at which the subject

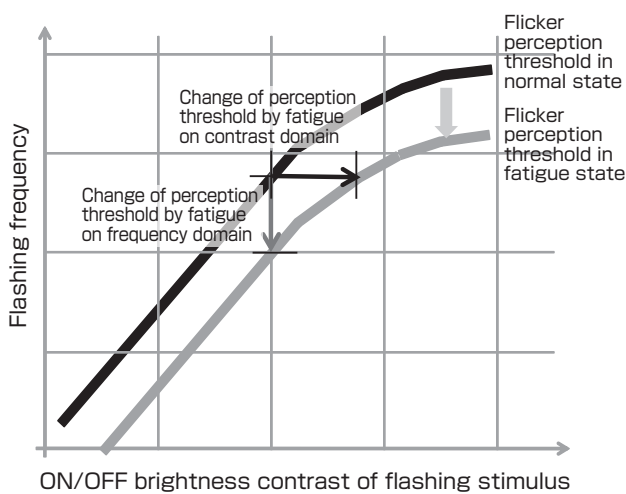
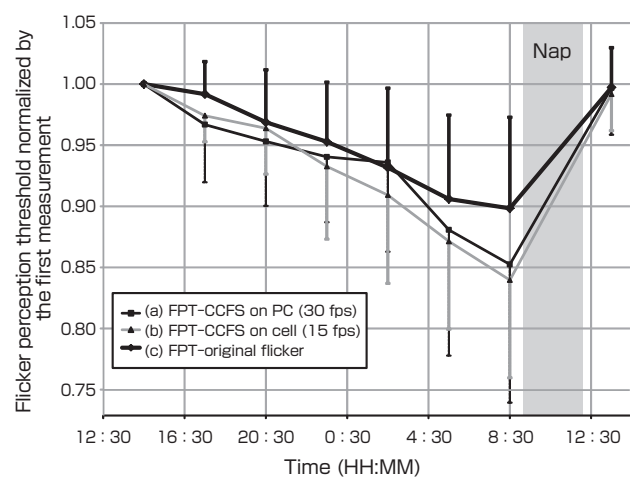

**Fig. 2 Relationship between the flashing frequency and ON/OFF brightness contrast in the flicker perception**

perceived the flicker (CFF) was measured under the constant brightness contrast. In contrast, the change of FPT due to fatigue can be also characterized by using the brightness contrast threshold under the constant flashing frequency. Using this characteristic, it is possible to measure the change of FPT due to fatigue in an image display device with fixed refresh rate.

We devised the contrast-controlled flicker stimulus (CCFS) method<sup>[17]</sup> that allows fatigue measurement with accuracy equivalent to the conventional flicker test, by changing the brightness contrast between high (ON) and low brightness (OFF) of the flashing visual stimuli, rather than changing the flashing frequency as in the conventional flicker test. Figure 3 shows the measurement results of the state of mental fatigue accumulation as the subject engages in the office work such as creating materials on a computer from 14:30 to 8:30 the next day, using: (i) the CCFS implemented on a cell phone with display of refresh rate of 30 Hz; (ii) the CCFS implemented on a personal computer with display of refresh rate of 60 Hz; and (iii) the specialized device (RDF-1, Sibata Scientific Technology Ltd.) for conventional flicker test (average of 12 subjects; error bar represents the standard deviation). In all methods, accumulation of mental fatigue due to the overnight work and the recovery of fatigue by short naps were appropriately measured as in the conventional flicker test. It was also found that the results obtained by CCFS flicker test were significantly correlated with the test results of the conventional flicker test (Fig. 4).

These results show that the FPT measurements by CCFS implemented on the widely available consumer devices can be used as an alternative to the original flicker test which requires the specialized device in evaluating the progressive



**Fig. 3 Results of the fatigue measurement under overnight workload<sup>[17]</sup>**

Measurements conducted by contrast-controlled flicker stimuli (CCFS) application implemented on a cell phone (thin grey line) and a PC (thin black line), and by a specialized device for conventional flicker test (thick line).



development of fatigue due to overnight mental workload.

### 3.2 Autonomous measurement of flicker perception threshold without the examiner

In the conventional flicker test, the method of limits is used where the flashing frequency is gradually and continuously changed at fixed intervals and the subjects are asked to respond by pushing the button at the moment he/she subjectively perceives the flickering sensation, and it is difficult to eliminate the contamination from biases including the subject's arbitrariness in responding to the perception of flickering sensation. This has not been a major problem as far as the method was used in the laboratory setting where the examiner and examinee sat face-to-face during data collection, hence the examiner could intervene as needed to avoid the possibility of the contamination. On the other hand, it is going to be an important issue to be solved when the method is applied to the measurement of flicker perception threshold in daily life where the examinee has to conduct the test autonomously without an examiner.

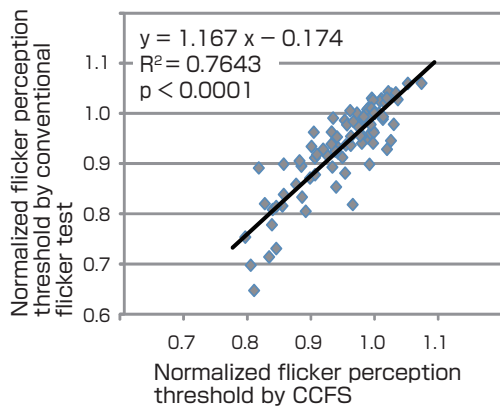

Fig. 4 Correlation between the flicker perception threshold measured using the contrast-controlled flicker stimuli (CCFS) and the conventional frequency-controlled flicker stimuli<sup>[17]</sup>

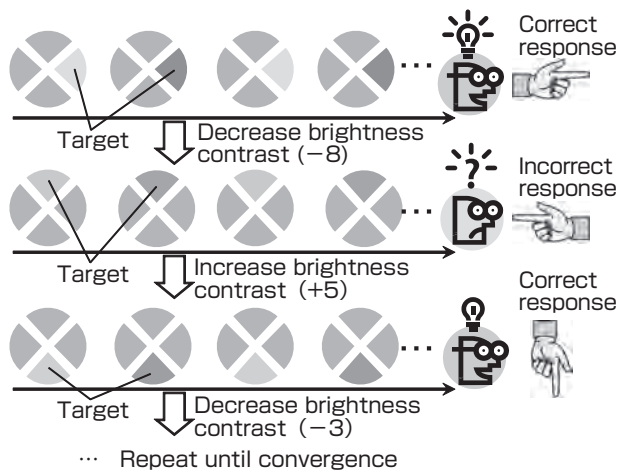

Fig. 5 Schematic diagram for the method of determining the flicker perception threshold by the forced-choice up/down (FCUD) method

To solve this issue, we introduced the forced-choice up/down (FCUD) method which adjust the stimulus parameter, brightness contrast in this case, adaptively corresponding to the subject's response so that the parameter converges to the flicker perception threshold.<sup>[17]</sup> Specifically, as shown in the schematic diagram of Fig. 5, the subject is required to choose a flickering target stimulus among the multiple stimuli presented. If the subject's reaction is correct, i.e., the subject chooses the flickering target stimulus which is randomly placed among other stationary alternatives, the brightness contrast of the target stimulus is decreased in the next trial to make the forced-choice task more difficult. Otherwise, the brightness contrast of the target is increased in the next trial until the subject can make a right choice. These steps are repeated until the brightness contrast is converged to the flicker perception threshold.

The accuracy of the flicker perception threshold measurement can be improved by using FCUD algorithm since it allows denser sampling around the perception threshold compared to the original flicker test where the brightness contrast is changed at a constant rate regardless of the subject's response (Fig. 6). The FCUD also contributes to reduce the amount of time required to complete the test by accelerating the convergence at the brightness contrast range where the flickering is less likely to be perceived (Fig. 6).

## 4 Integration of technologies for fatigue measurement in daily life

To verify the effectiveness of the techniques described in subchapters 3.1 and 3.2 to be used for the fatigue measurement in daily life, we created a prototype system combined with an online database to manage the measured

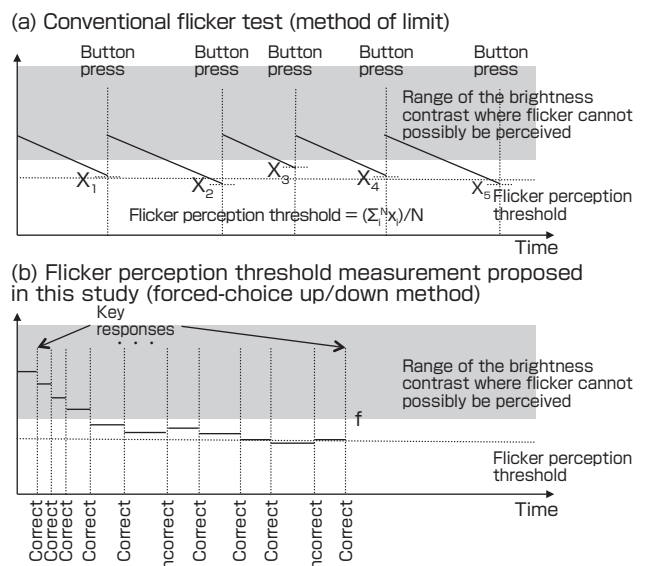

Fig. 6 Differences in the methods for determining the flicker perception threshold in the conventional and the proposed methods

data (Fig. 7). This system accomplished the following:

- (i) The CCFS (subchapter 3.1) enabled the presentation and control of flickering visual stimuli on the general-purpose display device,
- (ii) The FCUD-FPT algorithm (subchapter 3.2), which eliminates the subject's arbitrariness in measuring the flicker perception threshold, is implemented to enable appropriate fatigue measurement without the attendance of the examiner. It also contributes to reducing the overall time required to complete the test, and
- (iii) Online database was built to manage the measured data, where the fatigue data can be registered and referenced as needed from the application software installed on the terminal devices such as smart phones and PCs (Fig. 7).

We conducted actual trials on truck drivers in collaboration with transportation companies that are expected to be our potential users of the system. In the trial, the fatigue measurement was included as part of a dairy routine at the beginning and the end of work. Interview to the safety managers showed that reducing the time needed for testing to less than one minute was a critical factor in its implementation. Therefore, we achieved this goal by reviewing the convergence parameter of the FCUD-FPT algorithm. In the prototype system that was implemented on the personal computer, the time required for measurement was reduced to as short as 40 seconds compared to about 70 seconds with the conventional flicker test (Fig. 8).

### 5 Effect of realized outcome and new research topics

We have developed a set of techniques to bring the flicker test, which has been originally used to measure mental fatigue in the laboratory setting using specialized devices,

into our dairy life. We confirmed that the results obtained by our method, which is a combination of the CCFS and the FCUD-FPT algorithm, are compatible with those measured by the conventional flicker test. Our prototype system is being used for the long-term data acquisition trial in the business environment including two medium-sized transportation companies and in the R&D division of a major construction company. The above technology is also being commercialized by Flicker Health Management Co., Ltd. (FHM), an AIST Start-up (a venture company aiming to commercialize the AIST research outcomes).<sup>[18]</sup> Currently, the system is being used mainly to study the continuous changes in fatigue condition, which are originally measured by the conventional flicker test using specialized devices, at R&D division of information appliances companies, automobile companies, and university laboratories. The FHM also distributes free apps with simplified functions and operation for smart phones to be used by the general public, to promote diffusion of the fatigue evaluation technology in daily environment.<sup>[19][20]</sup>

Originally, the flicker test has a long history as a fatigue measurement method for academic purposes at research institutes, and it was used to evaluate the change of fatigue conditions in the time span of several hours to several tens of hours. The results of our research and development on the fatigue measurement provides low-cost alternative to the original flicker test, which has an established reputation for its robustness in tracking the changes of fatigue condition, using readily available devices. This allows not only the easy monitoring of the changes in fatigue condition in short periods that was done conventionally in laboratories, but also allows the continuous measurement over a long term of the daily changes in the degree of fatigue. These techniques can be applied to long-term monitoring of fatigue over a large subject population. There is no precedent research on

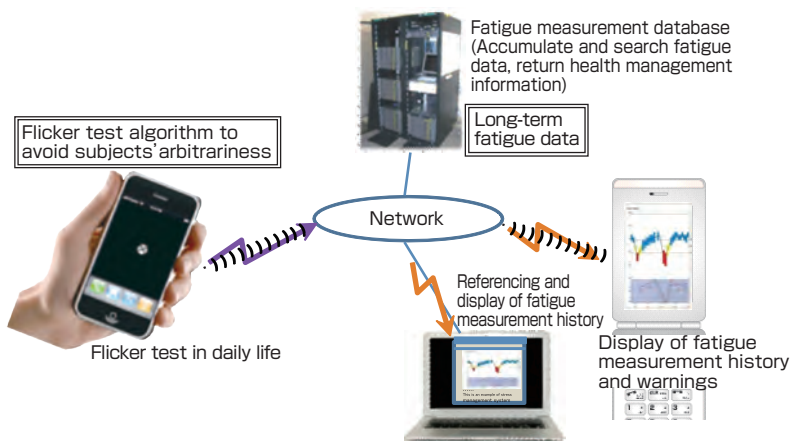

**Fig. 7 Prototype system of the mental fatigue measurement and management system that can be used in daily life**

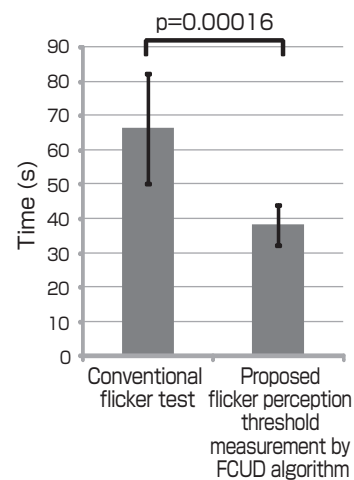

**Fig. 8 Comparison of time required for flicker perception threshold measurement by the conventional method and the FCUD method<sup>[17]</sup>**

quantitative evaluation of the chronic changes in fatigue. While it is not certain what kind of information can be extracted from the chronic fatigue data that are measured daily and continuously, it may be possible to use this technology effectively in various scenes in our society from health management at a personal level and improvement of our living environment to optimization of resource distribution and task efficiency in companies, based on the temporal change of mental fatigue conditions. We are starting to collect data to clarify the significance of conducting fatigue measurement continuously over a long term in the real living environment. Figure 9 shows an example where an engineer who works at a R&D division of a private company continuously measured the flicker perception threshold for five weeks including the summer vacation period using the Android smart phone app that we developed. While this is still in the preliminary stage, we are obtaining results that the changes in the daily fatigue level are related to the work and off-day patterns.

## 6 Summary and future development

We developed a low-cost, practical mental fatigue monitoring system to be used in daily life based on the measurement of flicker perception threshold (flicker test) which has been used conventionally for academic purposes in a laboratory setting. Our prototype system showed promise in implementing such a system just by installing the software in the general purpose personal devices, e.g. smart phones and PCs, which are readily available in daily life.

The remaining issue is to deal with the dependency of the flicker perception threshold on the changes in surrounding lighting environment and visual distance. Although the basic idea has been submitted for correcting the measurement result based on the lighting condition and visual distance using the camera function installed in the device (Japanese Patent # 4406705), verification based on real data has not

yet been done. For now, we instruct the users to conduct measurement under the same lighting and viewing conditions as much as possible, however, it is necessary to develop an additional technique for robust fatigue measurement in changing surrounding environments for further diffusion.

The flicker perception threshold is also affected by age and eyesight of the user as well as the display performance of the information device. In the laboratory setting, the variation by examinees can be standardized by using the results of the reference measurements conducted at the start of the experiment or before applying workload (standard value), but it is expected that the standard value cannot be obtained accurately for continuous measurements in daily life. We are developing an algorithm to determine the standard value appropriately from the previously acquired data.

For the future application of the proposed technique to the screening of fatigue related diseases as well as for multifaceted understanding of mental fatigue conditions, it is also necessary to clarify the correlation between FPT and the biochemical indices such as the changes in various biomarkers obtained from blood or saliva samples. We are working with the Health Research Institute, AIST to collect blood and saliva samples simultaneously as the flicker test during overnight work load. The current results indicate that there is a significant correlation between the changes in FPT and the oxidative stress marker in the blood samples.<sup>[21]</sup>

Since there have not been any methods to evaluate long-term changes in fatigue condition quantitatively in daily life, it is not certain what information is embedded in the fatigue data acquired over several months or years. The future topics include the development of a health management system that combines our fatigue measurement technique and time-series data processing algorithms to extract useful healthcare information, as well as application to enhance work efficiency through appropriate management of fatigue

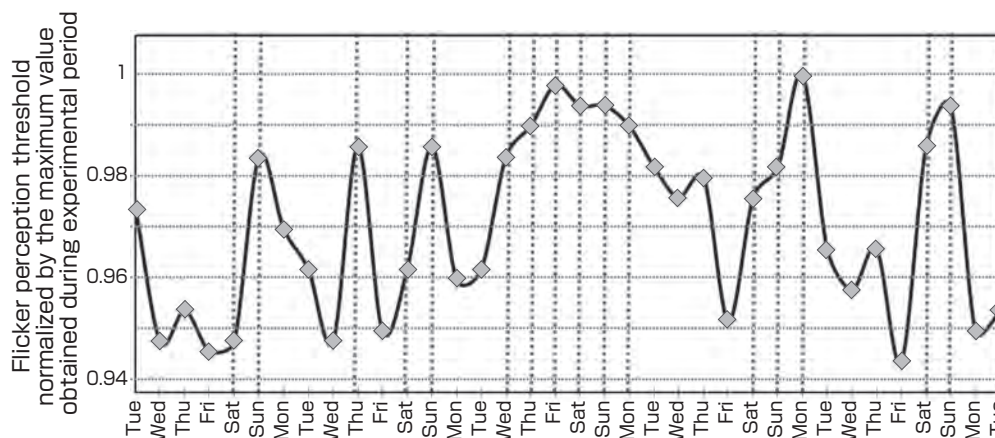

**Fig. 9 Preliminary data to show relationship between changes in the flicker perception threshold and work/off-day pattern obtained by continuous measurements over five weeks for an office worker (at a R&D division of a private company). Broken lines denote off-days.**

among workers. These topics are also important to enhance the range of application of this technology, and we plan to continue developing the data analysis algorithms and collecting long-term data in various environments through close collaboration with industries including the venture company for technology transfer from AIST.

## Acknowledgements

Part of this research was conducted with the research grant from the Mitsui Sumitomo Insurance Welfare Foundation (FY 2011) and the science and technology grant from the Suzuki Foundation (FY 2011~2012), and with the support of the Start-up Development Strategy Task Force, Venture Development Center, AIST (FY 2008~2009).

## References

- [1] Jidosha Unso Jigyo Ni Kakawaru Kotsu Jiko Yoin Bunseki Hokokusho, Heisei 19 Nendo (Report on the Analysis of Causes of Traffic Accidents in Automotive Transportation Enterprises, FY 2007), Committee on the Analysis of Causes of Traffic Accidents in Automotive Transportation Enterprises, Ministry of Land, Infrastructure, Transport and Tourism (2008) (in Japanese).
- [2] N. Tachi: Shinban "Jikakusho Shirabe" no teian to kaitei sagyo keika (Proposals for new edition "Jikakusho Shirabe (survey of subjective symptoms)" and work progress), *Digest of Science of Labour*, 57 (5), 299-304 (2002) (in Japanese).
- [3] M. Kuroda, T. Ishizaki, T. Maruyama, Y. Takatsuka and T. Kuboki: Effect of dried-bonito broth on mental fatigue and mental task performance in subjects with a high fatigue score, *Physiol. Behav.*, 92 (5), 957-962 (2007).
- [4] K. Saito: Measurement of fatigue in industries, *Indust. Health*, 37, 134-142 (1999).
- [5] L. R. Hartley, P. K. Arnold, G. Smythe and J. Hansen: Indicators of fatigue in truck drivers, *Appl. Ergonomics*, 25 (3), 143-156, (1994).
- [6] Y. Kaseda, C. Jiang, K. Kurokawa, Y. Mimori and S. Nakamura: Objective evaluation of fatigue by event-related potentials, *J. Neurol. Sci.*, 158 (1), 96-100 (1998).
- [7] E. Simonson and N. Enzer: Measurement of fusion frequency of flicker as a test of fatigue of the central nervous system, *J. Indust. Hyg. Toxicol.*, 23, 83-89 (1941).
- [8] R.W. Porter: New test for finger-tip sensation, *Br. Med. J.*, 2 (5519), 927-928 (1966).
- [9] S. Kitano, Y. Yoshida, K. Kawano, N. Hibi and E. Niki: Oxidative status of human low density lipoprotein isolated by anion-exchange high-performance liquid chromatography - Assessment by total hydroxyoctadecadienoic acid, 7-hydroxycholesterol, and 8-iso-prostaglandin F (2alpha), *Analytica Chimica Acta*, 585 (1), 86-93 (2007).
- [10] M. Maes, I. Mihaylova, M. Kubera, M. Uytterhoeven, N. Vrydags and E. Bosmans: Coenzyme Q10 deficiency in myalgic encephalomyelitis/chronic fatigue syndrome (ME/CFS) is related to fatigue, autonomic and neurocognitive symptoms and is another risk factor explaining the early mortality in ME/CFS due to cardiovascular disorder, *Neuro Endocrinol. Lett.*, 30 (4), 470-476 (2009).
- [11] K. Miwa and M. Fujita: Fluctuation of serum vitamin E (alpha-tocopherol) concentrations during exacerbation and remission phases in patients with chronic fatigue syndrome, *Heart and Vessels*, 25 (4), 319-323 (2010).
- [12] W. Karwowski (ed.): *International Encyclopedia of Ergonomics and Human Factors, 2nd Edition*, CRC Press, (2006).
- [13] K. Hashimoto: Physiological meaning of the critical flicker frequency (CFF) and some problems in their measurement: Theory and practice of the flicker test, *Jap. J. of Indust. Health*, 5 (9), 563-578 (1963) (in Japanese).
- [14] K. Hashimoto: Measurement of general fatigue, *Ergonomics*, 17 (3), 107-113 (1981) (in Japanese).
- [15] S. Hecht and C.D. Verrijp: The influence of intensity, color and retinal location on the fusion frequency of intermittent illumination, *Proc. Natl. Acad. Sci.*, 19 (5), 522-535 (1933).
- [16] S. Hecht and C.D. Verrijp: Intermittent stimulation by light: IV. A theoretical interpretation of the quantitative data of flicker, *J. General Physiol.*, 17 (2), 269-282 (1933).
- [17] S. Iwaki and N. Harada: Mental fatigue measurement based on the changes in flicker perception threshold using consumer mobile devices, *Adv. Biomed. Eng.*, 2, 137-142 (2013).
- [18] Flicker Health Management Co., Ltd.: Top page, <http://www.fhm.co.jp/>,
- [19] Flicker Health Management Co.,Ltd.: Application page, <https://play.google.com/store/apps/details?id=fhm.lite.application>,
- [20] Flicker Health Management Co., Ltd.: iTunes preview, <https://itunes.apple.com/jp/app/fhm-lite/id630387485?mt=8>
- [21] M. Shichiri, N. Harada, N. Ishida, L.K. Komaba, S. Iwaki, Y. Hagihara, E. Niki and Y. Yoshida: Oxidative stress is involved in fatigue induced by overnight deskwork as assessed by increase in plasma tocopherylhydroquinone and hydroxycholesterol, *Biol. Psychol.*, 94 (3), 527-533 (2013).

## Authors

### Sunao IWAKI

Completed the doctorate course at the Graduate School of Engineering, The University of Tokyo in 1998. Ph.D. in Engineering. Joined the Electrotechnical Laboratory in 1998. Currently, Leader of Cognition and Action Research Group, Human Technology Research Institute, AIST. Professor of Collaborative Graduate Program, Graduate School of Comprehensive Human Sciences, University of Tsukuba. Engages in the development of highly accurate, non-invasive visualization of human brain activity, its application to the objective evaluation of subjective perception and cognition, and the R&D of physiological and psychological index that can be used in daily life. In this paper, was in charge of the development of measurement algorithm for flicker perception threshold without arbitrariness to implement the fatigue measurement system on the general-purpose devices that can be used in daily life, and the drafting of the paper.



### Nobuyoshi HARADA

Completed the doctorate program at the Graduate School of Environmental Sciences, Hokkaido University in 1996. Ph.D. in Environmental Sciences. After serving as JST Fellow at National Institute of Biosciences and Human Technology, CREST Fellow, and NEDO Fellow, became the AIST Fellow in 2004. In 2010, became President of Flicker Health

Management Co., Ltd, a venture company that received technological transfer from AIST. Engages in research on the effect of information factors in the environment using 1/f fluctuation on brain functions, and on the business of intellectual rights of this research result and its technological diffusion. In this paper, was in charge of the verification experiment for the simple fatigue measurement system that can be used in daily life, the implementation for commercial use, and the collection of actual measurement data in real work environment.



## Discussions with Reviewers

### Overall comment (Motoyuki Akamatsu, AIST)

The manuscript describes the technological development that enables the users themselves to execute the flicker fatigue test, which had been used as a method of experimental fatigue measurement, in daily life, and also addresses the practical application of this technology. The scenario for the technological development describes how a technology used in academic research could now be used widely in society, and this is appropriate as a paper of *Synthesiology*.

### 1 Point of technological breakthrough

#### Comment (Motoyuki Akamatsu)

You explain one of the technological breakthrough points of using contrast instead of frequency, and I think the characteristic of this technology will become clearer if you expand more on this point. By just adding a sentence, “By utilizing the aforementioned characteristic, it is possible to measure the change in flicker perception caused by fatigue by changing the contrast, even in devices with fixed display frequency,” I think you can emphasize that this, in fact, is the breakthrough point.

#### Answer (Sunao Iwaki)

Based on your comment, I added two sentences that briefly explain the point of breakthrough in using the contrast threshold

for flicker perception at the end of paragraph 2 of subchapter 3.1.

### 2 Conventional fatigue measurement

#### Comment: (Katsuhiko Sakaue, Environment and Safety Headquarters, AIST)

In paragraph 3 of chapter 1, it is written that it is impossible for the general users to readily use the fatigue measurement based on objective index in daily life, but you do not address the perception and cognition indices that are the main subjects of this paper. Although it is explained in the following chapters, I think you should mention them in the same rank as other objective indices in this paragraph. It can be a brief summary, but please make some additions.

#### Answer (Sunao Iwaki)

As you indicated, I added the descriptions on perception and cognitive indices in chapter 1.

### 3 Index for flicker fatigue test using this method

#### Question (Motoyuki Akamatsu)

The vertical axis of Fig. 9 is different from other diagrams. Is this because the index value of fatigue has been established in the flicker fatigue test using frequency, but the value to be used as the index when using contrast has not been established?

#### Answer (Sunao Iwaki)

In the preliminary data obtained during the continuous use of our system in daily life as shown in Fig. 9, unlike the laboratory experiment where various parameters are controlled, there is no established method for explicitly setting the “standard value” (data that serves as the basis to normalize data with large personal variance; normally the measurement value before fatigue load is set as the standard value). This time, the largest value measured during the experimental period was set as the “standard value,” and the vertical axis of the graph was corrected so it will match the other graphs.

Also, a method to determine the “standard value” from the previously acquired fatigue data is thought to be an important point in practical application, and this could be a focus of future development which is being studied with the AIST venture company for technology transfer. I added paragraph 3 of chapter 3 to explain this point.

# Development of evaluation technologies for sedimentary characteristics

— Applicability of the technologies to the assessment of methane hydrate sediments —

Norio TENMA

[Translation from *Synthesiology*, Vol.7, No.4, p.228-237 (2014)]

Methane hydrate (MH) is considered to be part of a new generation of energy resources. Depressurization has been proposed as a method of extracting methane gas from MH in marine sediments. During depressurization, sediment deformation may occur because of MH dissociation and increased effective stress. It is therefore important to develop long-term, safe methods for protecting equipment used on the sea floor against the impact of deformation. We have developed the “COTHMA” geo-mechanical simulator to predict sediment deformation during methane gas production from MH. We have also performed laboratory experiments (push-out tests) of well integrity to determine model parameters. Deformation and stress in the vicinity of a production well were evaluated to assess the integrity of the well. Our technologies for evaluating sedimentary characteristics consist of the development of the geo-mechanical simulator and the evaluation of well integrity and wide-area deformation. Based on this research, we are now preparing technologies for practical application.

**Keywords :** Methane hydrate (MH), MH21 Research Consortium, COTHMA, geo-mechanics

## 1 Introduction

Methane hydrate (hereinafter MH) is a solid crystal in which the methane molecules are trapped in a basket of water molecules under high-pressure and low-temperature conditions. Environments where these high-pressure and low-temperature conditions exist include the permafrost zone on land and the sedimentary deposit layer at the continental margin in the sea (for example, 200–300 m below the seabed floor at ocean depths of 1,000 m or more). Under such conditions, MH exists in solid form. Lowering the pressure (depressurization) or raising the temperature causes the MH to break down into methane gas and water. Therefore, it has potential as a new natural gas resource. Surveys and research show MH to be present in abundance in the coast of Japan. The Methane Hydrate Resource Development Research Consortium (MH21) was set up in FY 2001 to promote MH resource exploration and development, and R&D is progressing.<sup>[1]</sup>

The Methane Hydrate Research Center (MHRC) at AIST, which is in charge of development of production methods in MH21, has proposed a depressurization method as an efficient method of gas production.<sup>[2]</sup> In this method, the pressure is decreased by pumping up water *in situ* from the sediment layer, thereby dissociating the MH into methane gas and water, and then collecting the methane gas. This depressurization method is likely to lead to, the deformation and consolidation of the MH, layer due to its dissociation as shown in Fig. 1. For example, when the sediment deforms

while the gas is being produced from the MH layer, local deformation may occur between the production well and the sediment, and this may lead to barriers to production, such as flow path formation or gas leakage. Sediment deformation may also affect the stability of structures such as the well itself, making safe and long-term production difficult to maintain. To enable safe and long-term gas production from the MH layer, it is therefore necessary to develop evaluation technologies, such as a numerical simulator, that are able to predict sediment deformation behavior.

However, the basic characteristics that must be handled in a numerical simulator such as “How do mechanical characteristics of the MH layer change during the dissociation process?” and “What role does MH play mechanically?” were not known at the start of the project, so we were unable to evaluate sediment deformation and consolidation. Therefore, “evaluation technologies for sedimentary characteristics” is being developed as a technology for safe and long-term gas production. As shown in Fig. 2, this technology is one of the developmental aims of gas production technology from the MH layer that will be explained below; MHRC conducts R&D as the main administrator of this area. The author is engaged in the development of evaluation technologies for sedimentary characteristics as the Deputy Director (also the Team Leader of Reservoir Simulator Team) of MHRC. The Reservoir Simulator Team is composed of a total of 14 people, including three researchers and technical staff, to develop evaluation technologies for sedimentary characteristics. The author is responsible for overall team management and the

---

Methane Hydrate Research Center, AIST Tsukuba West, 16-1 Onogawa, Tsukuba 305-8569, Japan  
\* E-mail: tenma-n@aist.go.jp

Original manuscript received January 14, 2014, Revisions received August 25, 2014, Accepted August 28, 2014

systematization of research. In this paper, I will discuss the progress made in evaluation technologies for sedimentary characteristics, concentrating on the topics handled by the Reservoir Simulator Team.

## 2 The work of the Methane Hydrate Resource Development Research Consortium (MH21)

In the Phase 1 period of FY 2001 to 2008, MH21 yielded many results, such as the calculation of the resource assessment for methane gas in the MH layer in Eastern Nankai Trough region and the successful continuous production by depressurization method in the onshore production test at Canada. Phase 2 was launched in April 2009, with a scheduled completion date in FY 2015, “for evaluating at high reliability the potential for the methane gas in the MH layer to be used as an energy resource and for identifying the technological challenges necessary to organize the technologies for commercial development of

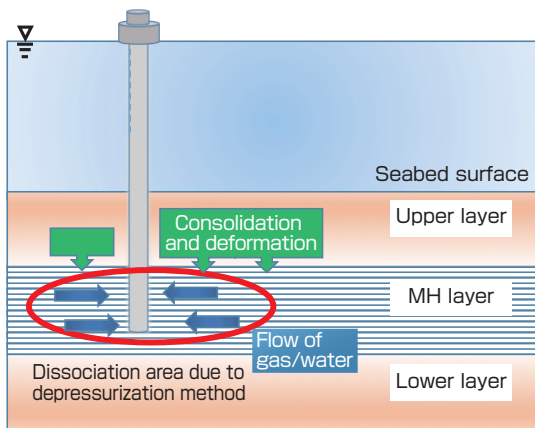

**Fig. 1 Mechanical behavior of the MH layer**

It is predicted that sediment deformation will occur by the MH dissociation and consolidation during the depressurization operation.

the MH layer, through R&D such as the offshore production test in the coast of Japan.” In Phase 2, Associate Professor Yoshihiro Masuda of the University of Tokyo was appointed the Project Leader. The R&D is being conducted by the Research Group for Field Development Technology, the Research Group for Production Method and Modeling, the Research Group for Resource Assessment, and the Group of Administrative Coordination in MH21. In March 2013, the first offshore production test was conducted for the first time in the world in the Daini Atsumi Knoll of the Eastern Nankai Trough. This test was conducted: (1) to demonstrate that gas can be produced from hydrates by the depressurization method and to confirm gas productivity, and (2) to establish the technology needed to apply the depressurization method at relatively shallow depths below the seabed floor. About 120,000 m<sup>3</sup> of gas was produced in six days using the depressurization method. Valuable data was also obtained for reservoir evaluation. Based on the data obtained in this field test, various research groups and teams are currently collaborating and conducting detailed investigations into the diverse phenomena of the MH layer.

Similar research is in progress around the world, such as in the United States, Korea, China, and India. For example, Korea is engaging in a gas hydrate survey in the Tsushima Basin, and the US is surveying reserves, along with the earthquake exploration surveys, in the Gulf of Mexico,<sup>[3]</sup> however, no offshore production tests have yet been conducted.

As the administrator of the Research Group for Production Method and Modeling, MHRC engages in R&D for various production methods, including the depressurization method.<sup>[4]</sup> In Phase 1, several production methods, including depressurization and heating methods, were investigated. The depressurization

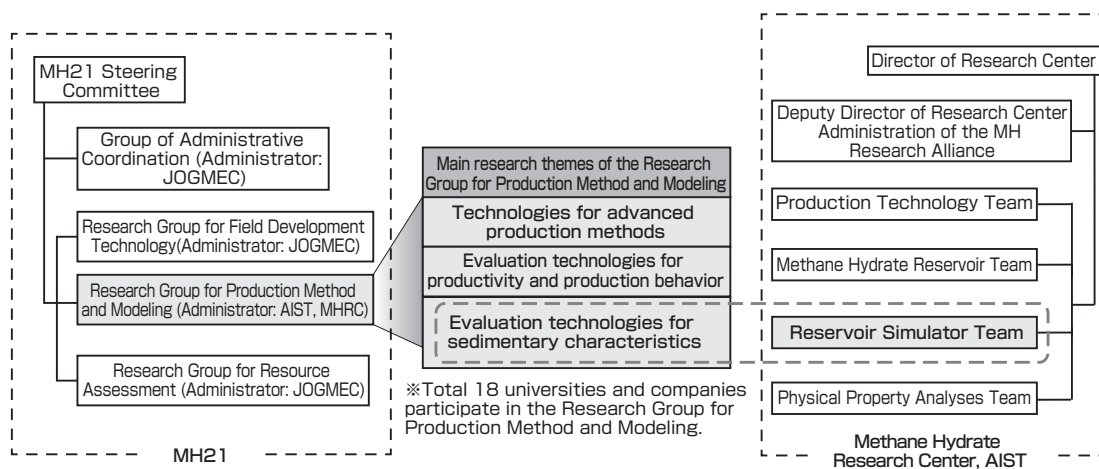

**Fig. 2 Relationship between the Research Group for Production Method and Modeling and the Reservoir Simulator Team, and research themes**

In the Methane Hydrate Resource Development Research Consortium (MH21), the Methane Hydrate Research Center (MHRC) oversees the R&D as the administrator of the Research Group for Production Method and Modeling. The Reservoir Simulator Team engages in the development of evaluation technologies for sedimentary characteristics as a research team within the MHRC.

method was proposed for reasons of its energy efficiency. In Phase 2, the depressurization method is being applied to further develop the complex production method (combined method) to stably produce large volumes of methane gas, to improve the production simulator (MH21-HYDRES) by looking at how closely its predictions match the actual production tests, and to evaluate wide-area sediment deformation that takes place during methane gas production. Specifically, methods of obtaining a high productivity and recovery rate are being developed as “technologies for advanced production methods,” and long-term, stable production is attempted through the development of quantitative analysis and numerical models of the production impediment factors such as sand problems, skin formation, fine-grain sand accumulation, decreased permeability due to compression, or flow blockages that occur during MH reformation, as well as the development of technologies to control and counter such impediments. We also engage in research into “evaluation technologies for productivity and production behavior” with the aim of developing a practical simulator by increasing the accuracy of the production simulator, through the development of a reservoir model to which the discontinuity and heterogeneity of the reservoir are introduced as parameters, and its degree of matching with laboratory experiments. Research on “evaluation technologies for sedimentary characteristics” is also being done to guarantee the long-term safety of the sediment deformation and consolidation behavior due to methane gas production from the MH layer.

### 3 Evaluation technologies for sedimentary characteristic

Since sediment deformation accompanying gas production from the MH layer is predicted, the development of technology that ensures safe and secure production in the development areas over the long-term is important for reasons of social and legal acceptability. This is particularly true for the development areas as shown in Fig. 3, in which it is necessary to evaluate the effects of fault discontinuity

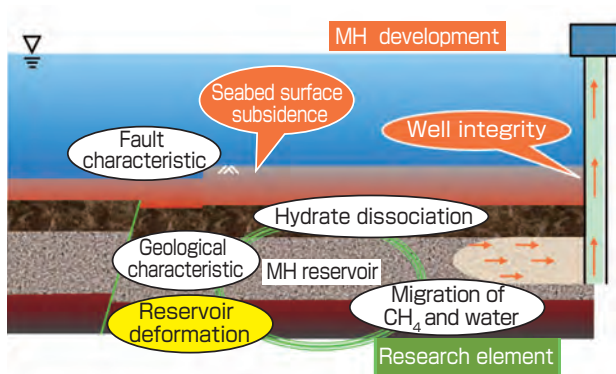

**Fig. 3 Development of evaluation technologies for sedimentary characteristics in the MH development**

To establish a long-term, safe, and secure production method, it is necessary to solve various issues on sedimentary characteristics.

and sediment heterogeneity on seabed floor subsidence or sediment deformation, along with deformation behavior within the MH layer. It is also necessary to analyze the changes in deformation and strength of the sediment from the early stage of development to be able to evaluate the long-term effects through comparison of factors before development to after well abandonment. Moreover, since there will be large stress differences in the well during the application of the depressurization method, it is necessary to analyze the stress on the well and to evaluate well integrity throughout the production period. To solve these issues through “sedimentary characteristic evaluation technology,” the Research Group for Production Method and Modeling is engaged in: (1) development of a geo-mechanical simulator, (2) evaluation of well integrity, and (3) evaluation of wide-area deformation, on which the R&D is being carried out in collaboration with private companies and universities within the MH21 framework.

Specifically, for (1) the development of the geo-mechanical simulator, the COTHMA, which will be explained later, is being developed. Various mechanical parameters of the MH layer are also being collected to enable the assessment of the deformation and compression behavior of the MH in the simulator.

In (2), the evaluation of well integrity, the sediment deformation and stress distribution in the vicinity of the production well during the application of the depressurization method are analyzed and evaluated based on the geo-mechanical simulator. Physical properties of wells for well integrity estimation are also being collected.

Moreover, in (3) evaluation of wide-area deformation, the method of analyzing the effects of discontinuities such as faults and sediment heterogeneity on seabed floor subsidence or sediment deformation are being surveyed and investigated; and sensitivity analysis using the simulator is being carried out. The sediment deformation and change in strength during the period from start of development to well abandonment are analyzed, and the long-term effect of development is evaluated by comparison with the situation before MH development. These subjects are interrelated as shown in Fig. 4. The goal is to develop a “geo-mechanical simulator” that combines the knowledge of “evaluation of well integrity” with “evaluation of wide-area deformation” (which will be explained below), and ultimately to provide various information necessary to plan the MH development.

With the framework of MH21, the Reservoir Simulator Team of MHRC collects mechanical parameters through laboratory experiments for (1) the development and advancement of the geo-mechanical simulator, and applies integrated evaluation of the mechanical characteristics of the deep-water unconsolidated deposit layer that is unique to MH



development. It also engages in (2) the evaluation of well stability by looking at the stress distribution in the vicinity of wells during the application of the depressurization method.

In the following section, details will be given on the outline and calculations of the geo-mechanical simulator that the Reservoir Simulator Team is currently developing, the research on the contact surface characteristic conducted as part of well integrity, and the evaluation of wide-area deformation conducted through collaboration with private companies and universities within the MH21 framework.

### 3.1 Development of the geo-mechanical simulator

For the numerical analysis of sediment deformation, development and use are pursued in the fields of civil engineering and architecture. Normally, laboratory experiments are conducted using on-site cores to collect parameters such as the elastic modulus that reveals how much the sediment deforms with pressure. The stress distribution and the amount of strain within the sediment layer are then calculated using the finite element method (FEM) using these parameters.<sup>[5]</sup> However, in gas production from the MH layer, the MH that is originally present in the layer in solid form dissociates into water and methane gas by the depressurization method, and the stress distribution in the layer changes as the MH that previously existed in solid form disappears. Moreover, the gas and liquid that are produced by dissociation can move through the sedimentary layers. Since MH dissociation is an endothermic reaction, heat exchange takes place within the layer. Therefore, unlike with general sediment deformation, it is not possible to analyze the sediment

deformation behavior in MH development until the simulator can handle the mechanical parameters for the elastic modulus and strength of the MH bearing sand sediment, the flow of gas and liquid in the layer, and the changes in temperature due to the dissociation and formation of MH. Therefore, jointly with West Japan Engineering Consultants, Inc. (WJEC) which has experience in numerical simulation and analysis of sediment deformation, a geo-mechanical simulator for MH bearing sand sediment was developed by adding functions for multi-phase flow analysis, heat conduction analysis, and MH dissociation and formation, to the sediment deformation numerical simulator.<sup>[6][7]</sup> The handling of mechanical MH parameters, which will be explained below, and the basic design of the numerical simulator were conducted mainly by the Reservoir Simulator Team. Currently, it has become a FEM with combined functions for stress, multi-phase flow, heat conduction, MH dissociation/formation, among others. The simulator is called the “Coupled Thermo-Hydro-Mechanical Analysis with Dissociation and Formation of Methane Hydrate in Deformation of Multiphase Porous Media” (COTHMA). Recently, deformation simulators with functions similar to COTHMA have been proposed,<sup>[8][9]</sup> but as it will be explained later, COTHMA was developed based on the laboratory experiment results from core samples of MH bearing sand sediments. It is a simulator that can most accurately represent the mechanical behavior of MH bearing sand sediments. The following are the characteristic functions of COTHMA that is under development and improvement.

- 1) Analysis of complex processes in multiple phases (vapor, liquid, and solid).

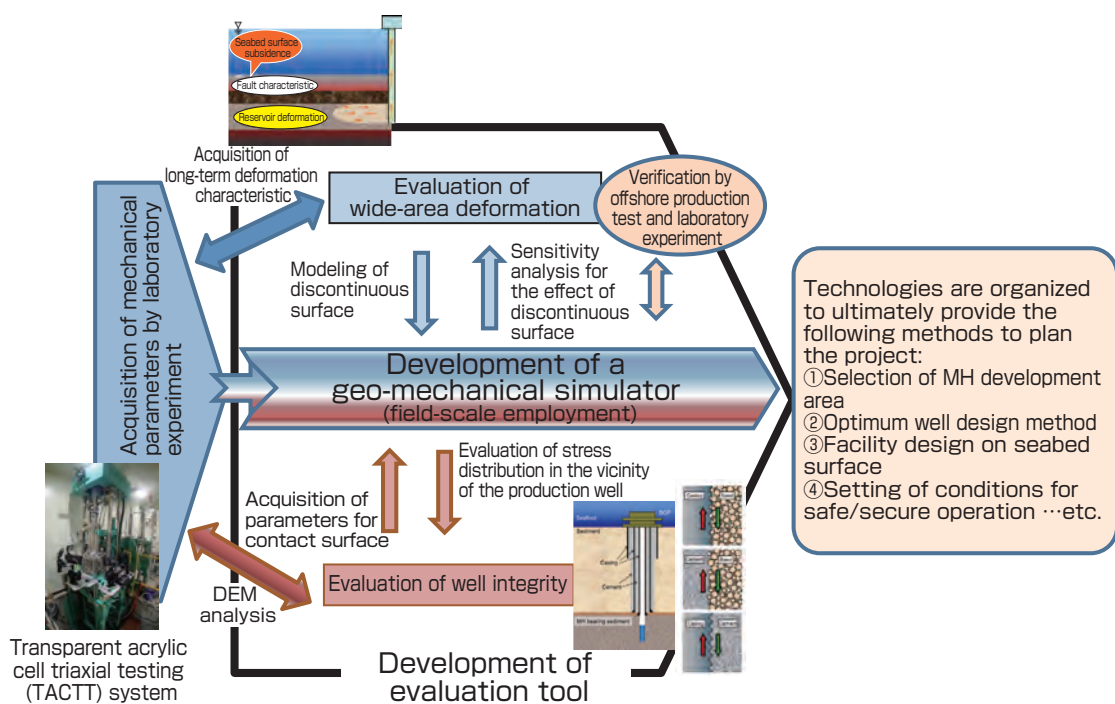

**Fig. 4 Development of evaluation tool for sedimentary characteristics**

Tools are developed while integrating the results of the evaluations of well integrity and wide-area deformation that are currently being done.

- 2) Application for various production methods (depressurization method, thermal recovery method, and combined method) to extract methane gas from MH sediment.
- 3) Treatment of MH dissociation/re-formation.
- 4) Treatment of ice solidification/melting.

So far, reproduction of the laboratory experiment results has been carried out to validate the simulator.<sup>[10][11]</sup> Various sensitivity analyses were conducted on a field scale using this simulator.<sup>[12]</sup> Figure 5 shows an example of predictive investigation conducted using the simulator on a field scale.<sup>[13]</sup> The model used is an axisymmetric model of the 2D cylindrical coordinate system, with the well as the central axis. The right-half region of the well is broken down into its elements. In this model, there is a MH layer sandwiched between mud layers. A simple model is assumed for the MH layer of alternating sand-mud layers, based on field surveys. Specifically, the thickness is set at 1 m each of alternating sand and mud. The calculation is done assuming that depressurization takes place in the section in which the well reaches the MH layer. The contour diagram of water pressure, MH saturation, and deformation of 1 day, 10 days, and 100 days after the start of the operation

of depressurization are shown. As it can be seen from the water pressure change, the area with decreased water pressure in the vicinity of the depressurization zone spreads after the start of depressurization. The low-pressure area spreads by the depressurization method, and the MH dissociation area spreads in the sand layer corresponding to such areas. The effect of deformation by MH dissociation and consolidation can be seen in the sand layer. As the MH dissociation area spreads, the overall deformation of the alternating sand-mud layers progresses. Particularly, the effects caused by consolidation and MH dissociation coexist in the deformation, and the effect manifests in a greater area than the dissociation area. However, the calculations show that the subsidence gradually decreases and that the area in the vicinity of the well stabilizes after a certain degree of subsidence. Since the effects of MH dissociation can be seen, the deformation is thought to be greater than the consolidation deformation of the layer, but it appears that the deformation gradually subsides, since the structure within the sand layer is maintained to some degree, even after dissociation of the MH. Our current numerical model is constructed based on the knowledge of sensitivity analyses and the information from the first offshore production

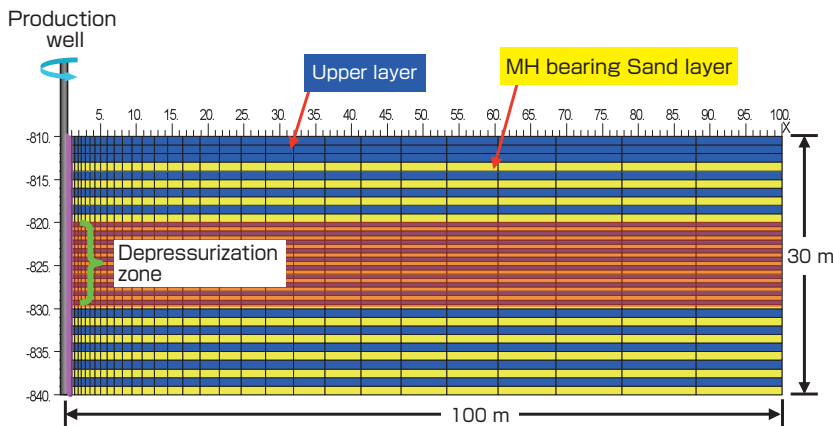

(a) Diagram of the field-scale model used in preliminary investigation

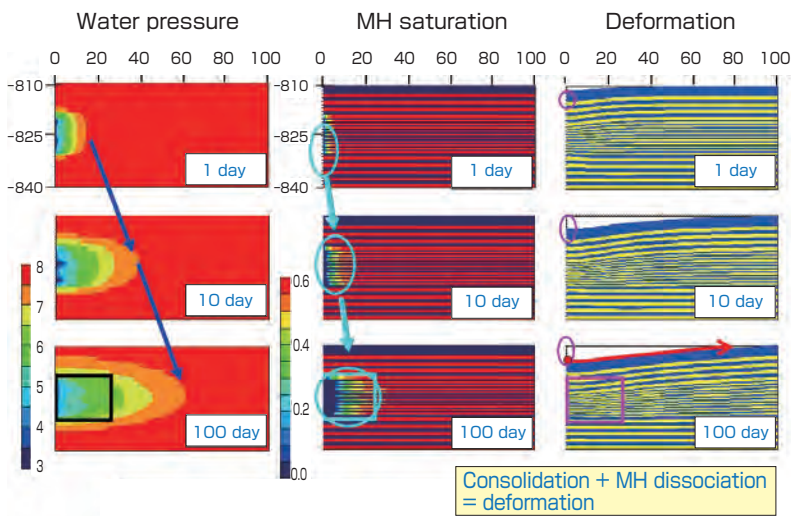

(b) Contour diagram of calculation result (water pressure, MH saturation, deformation)

**Fig. 5 Example of field-scale sensitivity analysis result**

This is a contour map that investigates the deformation during the operation of depressurization using the field-scale simplified model. The effects of deformation caused by MH dissociation and consolidation of the MH layer are shown.

※ Deformation values of the contour map are expressed at 30 times the calculated values.

test. Analysis and evaluation continues for the deformation behavior during gas production.

Parameters such as elastic modulus and strength (peak value of stress) of the MH-bearing sand sediments had never been measured, and it was impossible to obtain a core sample of the MH layer. It was therefore necessary to prepare samples and develop a testing device specifically for MH to obtain these parameters. The ways to make the artificial MH specimens were investigated by collaborating with universities and private companies utilizing the MH21 framework. We established a way to make such specimens by injecting the gas into a frozen sand specimen and then melting it at a certain pressure and temperature. We succeeded in redesigning and developing a triaxial testing device, originally designed for use in conventional soil studies, to handle the artificial specimens. This enabled laboratory experiments to be carried out on MH. As part of the R&D of MH21, basic boring was conducted in the Tokai-oki to Kumano-nada area from late-January to mid-May 2004. Natural MH core samples were obtained successfully. The elastic modulus and strength values for the MH core were obtained by conducting laboratory experiments on this natural MH core and artificial specimen. It was found that the elastic modulus and strength increased as the MH saturation ratio (volume ratio of MH in the pore) increased.<sup>[14]-[18]</sup> The experimental equation was derived based on laboratory experiments results and incorporated into the geo-mechanical simulator. This enabled the analysis of the mechanical behavior of the MH layer.

We recently succeeded in obtaining a pressure core (a core in which a high pressure condition is maintained to prevent MH dissociation) at the offshore production test site in the summer of 2012. These cores are managed and stored at AIST Hokkaido. Detailed data analysis of the cores from

the MH layer is now being carried out. Moreover, to obtain accurate parameters for MH cores, a “transparent acrylic cell triaxial testing (TACTT) system” that allows laboratory experiments to be carried out while maintaining high pressure (Photo 1) was adopted for conducting the tests.<sup>[19]</sup> The chief characteristic of this device is that the natural core, collected with maintained high pressure, can be transferred to the device without loss of pressure; a sufficient confining pressure is applied through the rubber sleeve to conduct the triaxial test. The sample cell section is made by acrylic to enable visual observation of the triaxial test under high pressure. These techniques made it possible to gain an understanding of the local deformation of the core during the test. Visual observation could be made of the sheared section when stress was applied to the layer, and local deformation and strain could thus be quantified. This device contributes to improvement of the precision of the parameters used in the geo-mechanical simulator.

### 3.2 Evaluation of well integrity

We are working on evaluation of well integrity using the geo-mechanical simulator that is under development. For example, it is becoming apparent that the stress distribution vicinity production well varies according to the difference of depressurization rate (which means the period of decreasing pressure from hydrostatic pressure to 3 MPa at the bottom of the borehole).<sup>[20]</sup> To further improve precision of analysis, it is necessary to match the well model closely to the condition at the actual site. Wells are composed of numerous and complex materials, including the casing, cement, and sedimentary layers, and it is particularly important to understand the strength of the contact surfaces of these materials. However, there has not been much research on the contact surfaces of wells in deep-water or large depth conditions as seen in the case of MH layers. We are therefore conducting push-out tests to obtain these parameters in order to establish a well model that matches the actual site. Photograph 2 shows a sample

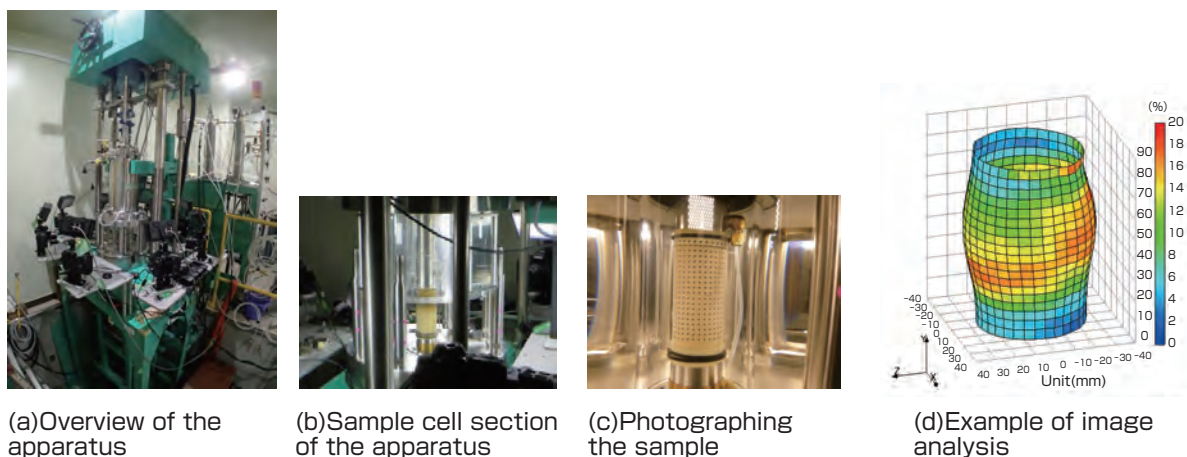

**Photograph 1. Transparent acrylic cell triaxial testing (TACTT) system**

(a) Overview of the apparatus, (b) sample cell section of the apparatus, (c) photographing the sample, and (d) example of image analysis. As it can be seen from the apparatus overview, the image can be obtained from multiple directions at the sample cell section, and the changes in the sample surface can be observed using the image data.<sup>[19]</sup>

prepared to obtain the contact surface strength between the casing and cement. The steel rod is placed in the hollow sample made of cement, and data on contact surface strength between the materials is collected by conducting the push-out test in which the rod is pushed through. So far, experiments on the contact surface strengths of casing-sediment, casing-cement, and cement-sediment have been conducted. For example, for the contact surface strength of casing-cement, we derived an experimental equation using the effective confining pressure among others as parameters.<sup>[21][22]</sup> In the future, we plan to conduct further sensitivity analyses using experimental equations such as this, and to propose a method for the well design of MH development.

At the contact surface, local deformations by particle crushing may occur, but it is difficult to understand the details of the local effect in the push-out test due to the settings of experimental conditions and experiment time. Therefore, investigation using the distinct element method (DEM) is carried out for evaluation by numerical analysis. Since the DEM is a method that tracks the motions of multiple particles, it is possible to quantitatively evaluate the micro-mechanical quantities that cannot be measured experimentally. Since it is known that the “roughness” of the contact surface is related to strength, we are attempting to systematize the unevenness of the well surfaces or sand particles at various scales of roughness using the DEM. By gaining a systematic understanding of the properties of the contact surface under various mechanical conditions by DEM, we hope to elucidate the mechanical behavior of the contact surface and its modeling.<sup>[23]</sup>

### 3.3 Evaluation of wide-area deformation

In development for practical use of MH, it is thought that long-term production may not be possible because depressurization cannot be maintained in cases where there are discontinuities such as faults in areas surrounding the points of MH development, as faults may become flow-paths as shown in Fig. 3. We are therefore investigating a way of evaluating the effects of discontinuous surfaces. In MH development, there is a risk that deformation behavior such as consolidation before, during, and after production may change greatly when using the depressurization method. This prompted us to investigate sediment characteristics over the long-term. The following two research studies are being conducted for evaluation of wide-area deformation. First, for the purpose of establishing a method of selecting MH development areas, we created a numerical model based on the Eastern Nankai Trough, and investigated the effect of sediment layer heterogeneity and fault discontinuity by including the presence of faults in the numerical model. Specifically, by comparing and investigating the mechanical behavior when the depressurization method is applied in the numerical model with and without faults, it is possible to understand the effect of discontinuities, such as faults, on the mechanical behavior. Sensitivity analysis is then conducted to understand the conditions under which the sediment layer condition is optimal for the MH development area. This type of location is then selected as the MH development area. The parameters of sensitivity analysis considered so far include the distance between well and fault, the dip angle of the fault, and whether the fault is normal or a reverse fault.<sup>[24]</sup> The results of the sensitivity analysis so far confirm that the deformation behavior changes at the

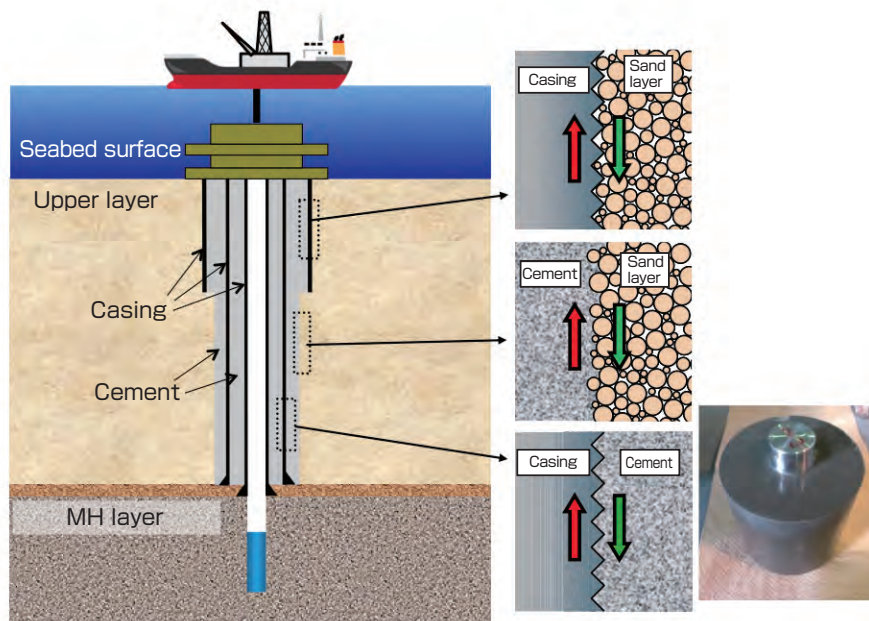

**Photograph 2. Sample for measuring the contact surface strength between the casing and cement (part of the diagram has been modified)<sup>[21]</sup>**

Since the well is a combination of complex materials of casing, cement, and sedimentary layers, push-out tests were conducted by preparing various samples with combinations of different materials.

fault during the depressurization operation. In the future, we plan to systematize the effects of sediment deformation on each parameter and establish a way of selecting sites that are suitable for MH development.

We also analyzed the sediment deformation and strength change during the period from start of MH development to well abandonment, and evaluated the long-term effects of MH development by comparing the situation before and after MH development. Specifically, using the artificial MH specimen made in the particle size distribution obtained from exploratory drillings of the MH layers, the triaxial test is conducted under the conditions assumed for the situation before and after gas production. During the application of the depressurization method (i.e., during production) and during the recovery of water pressure after the stop of the depressurization operation (i.e., after production), the liquid pressure in the layer changes, and therefore the deformation strength characteristics before and after gas production can be understood by conducting tests in which the liquid pressure in the pore of the artificial specimens is varied.<sup>[25]</sup> In the future, we plan to further develop a constitutive equation using the deformation strength obtained from the laboratory experiments, and to embark on long-term sediment deformation analysis by incorporating such equations into the geo-mechanical simulator.

#### 4 On future R&D

The “Basic Plan on the Ocean Policy” which was approved by the Cabinet on April 26, 2013, contains the following statement: “The preparation of technology shall be conducted to achieve commercialization with FY 2018 as the goal, taking into account the results of the offshore production test, to make MH, which appears to be abundantly present in the coast of Japan, a future energy resource. In doing so, technological development will be promoted such that projects for commercialization led by private companies can commence in the latter half of 2018, taking into account the international situation.” Following the “Basic Plan on the Ocean Policy,” the “Plan for the Development of Marine Energy and Mineral Resources” is currently under revision. And it is thought that the long-term, stable production technology will be promoted. It is necessary to continue steady research for the evaluation technologies for sedimentary characteristics in the future.

Currently, a 3D model has been constructed and is being updated based on the results of core analysis obtained in the field test site. Analysis and evaluation of the mechanical behavior of the MH layer are being carried out through the investigation of offshore production test. We plan to continue improving the geo-mechanical simulator through such investigations. The world’s largest laboratory experiment apparatus, the High-pressure Giant Unit for Methane Hydrate Analysis (HiGUMA) for the MH layer is set up

at AIST Hokkaido.<sup>[26]</sup> This is a device for evaluating the behavior of gas production and MH layer dissociation that cannot be understood by merely using core-scale laboratory experiments when the depressurization method is applied. Using this apparatus, we are attempting to measure the deformation behavior in the vicinity of wells during the depressurization operation. We hope to measure the deformation behavior when the depressurization method is applied, and to improve the precision of the geo-mechanical simulator through experimental verification.

By continuing the simulator development combining functions such as the MH development selection method established by evaluations for wide-area deformation evaluation and for well vicinity as mentioned in subchapters 3.2 and 3.3, we ultimately wish to develop a tool that contributes to the MH development area selection, the optimum well design method, and the design of equipment used on the seabed floor for gas production from the MH layer.

#### 5 Conclusion

In this paper, we discussed the “evaluation technologies for sedimentary characteristics” as follows: (1) the development of a geo-mechanical simulator, (2) the evaluation of well integrity, (3) the evaluation of wide-area deformation, and outline, result, and future development policy of this theme.

The proposal of a long-term, stable production technology for the future is important for the practical realization of MH development. The viewpoint of evaluation technology in terms of mechanical characteristics is the core technology. Our research so far, we believe, has achieved major success in the form of our numerical simulator that can help understand the mechanical characteristics of the MH layer and can handle the mechanical behavior of MH, through obtainment of the natural MH core that is the research subject, establishment of ways to make the artificial specimen, and comparison with the results of laboratory experiments using the natural MH core.

Verification of the results of the first offshore production test was also conducted through industry-academia-government collaboration based on the MH21 framework. These research activities also assisted the training of human resources for MH development. The development of various experimental apparatuses has also been accomplished through this research. By gaining a further understanding of the mechanical characteristics of the MH layer and by the improvement of the geo-mechanical simulator, we hope to apply the “evaluation technologies for sedimentary characteristics” to actual sites of gas production from MH sediments.

## Acknowledgements

This study was financially supported by the Research Consortium for Methane Hydrate Resources in Japan (MH21 Research Consortium) in the Japan research. By further understanding the mechanical y to continue mechanical behavior. In this paper, I am thankful to the members of the Reservoir Simulator Team, including researchers Dr. Jun Yoneda, Dr. Jun Katagiri, and Dr. Kuniyuki Miyazaki, as well as the people of MH21.

## References

- [1] MH21 Research Consortium, <http://www.mh21japan.gr.jp/english>
- [2] M. Kurihara, A. Sato, H. Ouchi, H. Narita, Y. Masuda, T. Saeki and T. Fujii: Prediction of gas productivity from Eastern Nankai Trough methane-hydrate reservoirs, *SPE Journal*, 125481-PA, (2009).
- [3] U.S. DOE: Fire in the Ice, *Methane Hydrate Newsletter*, 13 (2), (2013).
- [4] J. Nagao: Development of methane hydrate production method –A large-scale laboratory reactor for methane hydrate production tests–, *Synthesiology*, 5 (2), 89-97 (2012).
- [5] A. Fukada, M. Nakano, Y. Kawamura and T. Matsuda: LNG chika tanku shuhen morido no jishinji chinka yosoku kaiseki (Subsidence prediction analysis during earthquakes of the earth embankment around the underground LNG tanks), *Proc. 57th JSCE Annual Conf.*, 1087-1088 (2002) (in Japanese).
- [6] K. Aoki, Y. Ogata, A. Masui, J. Mori and K. Hou: Land subsidence due to development of Methane Hydrate, *Proc. 2003 MMIJ (A/B)*, 235-236 (2003) (in Japanese).
- [7] K. Aoki, Y. Ogata, A. Masui, J. Mori and K. Hou: Numerical analysis of land subsidence due to development of Methane Hydrate, *Proc. 2006 MMIJ (Fukuoka)*, (2006) (in Japanese).
- [8] M.Y.A. Ng, A. Klar and K. Soga: Coupled soil deformation-flow-thermal analysis of methane production in layered methane hydrate soils, *Proc. 2008 Offshore Technol. Conf.*, OTC19364, (2008).
- [9] S. Kimoto, F. Oka and T. Fushita: A chemo-thermo-mechanically coupled analysis of ground deformation induced by gas hydrate dissociation, *Int. J. of Mechanical Sciences*, 52 (2), 365-376 (2010).
- [10] Y. Sakamoto, M. Kakumoto, K. Miyazaki, N. Tenma, T. Komai, K. Aoki and T. Yamaguchi: Numerical study on consolidation and gas production behavior in a laboratory-scale experiment for dissociation process of methane hydrate by depressurization: Estimation of permeability in methane hydrate reservoir, Part 7, *Journal of MMIJ*, 126 (12), 631-639 (2010) (in Japanese).
- [11] K. Miyazaki, Y. Sakamoto, M. Kakumoto, N. Tenma, K. Aoki and T. Yamaguchi: Triaxial compressive properties of artificial methane-hydrate-bearing sediments containing fine fraction, *Journal of MMIJ*, 127 (9), 565-576 (2011) (in Japanese).
- [12] J. Yoneda, K. Miyazaki, N. Tenma and M. Hyodo: Prediction of long-term stratal deformation resulting from depressurization for methane hydrate extraction, *Proc. 13th Japan Symposium on Rock Mechanics*, CD-ROM, JSRM-64 (2012) (in Japanese).
- [13] M. Kakumoto, J. Yoneda, K. Miyazaki, N. Tenma, A. Masui, K. Aoki, H. Karasawa and R. Itoi: Preliminary study on well integrity during gas production from methane hydrate sediments, *Proc. Int. Symp. Earth and Technol. 2011*, CD-ROM (2011).
- [14] A. Masui, H. Haneda, Y. Ogata and K. Aoki: Effects of methane hydrate formation on shear strength of synthetic methane hydrate sediments, *Proc. 15th Int. Offshore and Polar Eng. Conf.*, 364-369 (2005).
- [15] A. Masui, K. Miyazaki, H. Haneda, Y. Ogata, and K. Aoki: Mechanical characteristics of natural and artificial gas hydrate bearing sediments, *Proc. 6th Int. Conf. on Gas Hydrates*, CD-ROM, (2008).
- [16] K. Miyazaki, A. Masui, K. Aoki, Y. Sakamoto, T. Yamaguchi and S. Okubo: Strain-rate dependence of triaxial compressive strength of artificial methane-hydrate-bearing sediment, *Int. J Offshore and Polar Eng.*, 20, 256-264 (2010).
- [17] K. Miyazaki, A. Masui, Y. Sakamoto, K. Aoki, N. Tenma and T. Yamaguchi: Triaxial compressive properties of artificial methane-hydrate-bearing sediment, *J. Geophys. Res.*, 116 (B6), 102 (2011).
- [18] K. Miyazaki, Y. Endo, N. Tenma and T. Yamaguchi: A nonlinear viscoelastic constitutive equation for artificial methane hydrate-bearing sand under triaxial compression, *Proc. 8th Int. Conf. on Gas Hydrates*, CD-ROM, (2014).
- [19] J. Yoneda, A. Masui, N. Tenma and J. Nagao: Triaxial testing system for pressure core analysis using image processing technique, *Rev. Sci. Instrum.*, 84, 114503 (2013).
- [20] N. Tenma, K. Miyazaki, J. Yoneda, M. Kakumoto, K. Aoki, J. Mori, A. Takiguchi and K. Hou: Sensitivity analysis for well integrity during gas production from methane hydrate sediments, *Proc. 3th Comprehensive Symposium on Methane Hydrate (CSMH-3 2011)*, 55-56 (2011) (in Japanese).
- [21] M. Kakumoto, J. Yoneda, K. Miyazaki, N.Tenma, K. Aoki and R. Itoi: Basic study on the frictional strength between the casing and cement in a methane hydrate production well, *Journal of MMIJ*, 129 (4), 116-123 (2013) (in Japanese).
- [22] J. Yoneda, M. Kakumoto, K. Miyazaki, J. Katagiri, N. Tenma and K. Aoki: Effect of surface roughness on frictional strength of casing in the sand under high confining pressures –Basic studies of well stability for methane hydrate development (Part 2)–, *Journal of MMIJ*, 129 (6), 278-283 (2013) (in Japanese).
- [23] J. Katagiri, J. Yoneda and N. Tenma: DEM simulation for evaluating the contact behavior between soil with solid, *Proc. 4th Comprehensive Symposium on Methane Hydrate (CSMH-4 2012)*, 207-208 (2012) (in Japanese).
- [24] E. Ogisako, S. Nishio and A. Denda: Case study on ground deformation in methane hydrate production, *Proc. 4th Comprehensive Symposium on Methane Hydrate (CSMH-4 2012)*, 136-140 (2012) (in Japanese).
- [25] N. Yokoyama, M. Hyodo, Y. Nakata, N. Yoshimoto and A. Kato: Triaxial shear characteristics of methane hydrate bearing sand simulated sediments of deep seabed in Nankai Trough, *Proc. 4th Comprehensive Symposium on Methane Hydrate (CSMH-4 2012)*, 145-149 (2012) (in Japanese).
- [26] Y. Konno, Y. Jin and J. Nagao: Study on enhanced methane hydrate recovery by using high pressure giant unit for methane hydrate analyses (HiGUMA), *Proc. 5th Comprehensive Symposium on Methane Hydrate (CSMH-5 2013)*, 54-55 (2013) (in Japanese).

## Author

### Norio TENMA

Joined the Agency of Industrial Science and Technology's National Institute for Resources and Environment in 1990. Specialized in numerical modeling and evaluation of heat extraction characteristics of geothermal reservoirs, and engaged in the development of numerical simulators. Transferred to AIST's Methane Hydrate Research Center in FY 2009 to engage in the development of a geo-mechanical simulator for MH development. Currently aims to develop the evaluation technologies for sedimentary characteristics.



## Discussions with Reviewers

### 1 Overall comment

**Comment (Hiroshi Tateishi, AIST Chubu; Yusaku Yano, AIST)**

This paper gives an overview of the developmental technology system for the "evaluation technology of sedimentary characteristics" within the R&D process at AIST's Methane Hydrate Research Center. The paper aptly summarizes the role of the Center in MH21, which is the administrative center of the national project for MH resource exploration, and the development of a geo-mechanical simulator which is the core technology, and evaluation of well integrity and wide-area deformation based on simulations. We consider this paper appropriate for *Synthesiology*.

### 2 The global positioning of MH development

**Question (Yusaku Yano)**

This paper discusses the technological development of MH exploration in Japan, which I believe is a challenge not faced anywhere else in the world in terms of new technology development. The readers may wish to know about the positioning of this technological development on the global stage. As background, in which regions or countries are MH resources distributed, and what is the level of technological development in other countries? What is the positioning of the Japanese technology concerning MH? Also, although MH21 has written a roadmap for development in Japan, are there any international research collaborations with the rest of the world? Is there a global roadmap?

**Answer (Norio Tenma)**

For the exploration of MH as a new resource, surveys are being carried out in the United States, Russia, Canada, China, and India, but their aims are chiefly to study the volumes of resource. Actual production technology is not being researched elsewhere in the world. Therefore, as concerns to global positioning, I have added the paragraph: "Similar research is in progress around the world, such as in the United States, Korea, China, and India. For example, Korea is engaging in a gas hydrate survey in the Tsushima Basin, and the US is surveying reserves, along with the earthquake exploration surveys, in the Gulf of Mexico, however, no offshore production tests have yet been conducted."

### 3 Relationship to existing resource exploration research

**Question (Yusaku Yano)**

On the point of using wells for production, MH is similar to conventional oil and natural gas, but I think you are adding a unique MH technological system to existing advanced technological systems for oil and natural gas production.

Unlike the construction of a technological system from blank, when adding a new technological system onto a large existing technological system, I believe one thinks of doing it more efficiently and effectively. For the development of evaluation technologies for sedimentary characteristics, is there previous research on oil and natural gas that could be referenced, and is the research progressing effectively by improving on such earlier research? Are you actually engaging in such activity?

**Answer (Norio Tenma)**

We believe that sediment deformation, such as subsidence while applying the depressurization method, is an important challenge when investigating the potential for long-term, stable production. The topic of subsidence, for example, has been investigated in the field of water-soluble natural gas exploration. We assume that a similar phenomenon will occur in MH exploration. We engaged in R&D to gain an understanding of the mechanical characteristic of the MH bearing sediment and to evaluate using numerical simulation, using approaches similar to those employed for natural gas extraction. For example, when understanding the mechanical characteristics of MH, we assumed that MH had been newly added to the sediment layer, so the research was done in reference to the test methods used in soil mechanics. Specifically, since our MH samples are affected by pressure and temperature, we investigated a method of conducting mechanical tests while controlling these factors. As described in subchapter 3.1, "Development of the geo-mechanical simulator," the MH simulated sample was made by injecting gas into the frozen sand sample. There was no method for calculating the specific physical property values until this method had been established, so we regard it as a major accomplishment. However, we have conditions that are not encountered in conventional research, such as the target of exploration being a non-consolidated layer several hundred meters below the seabed floor, not to mention the near-explosive depressurization that takes place when using the depressurization method (about 7 MPa depressurization in the first offshore production test). We are now conducting our research taking these differences into full account.

### 4 Relationship with the offshore production test

**Question (Hiroshi Tateishi)**

In the offshore production test in March 2013, what preliminary contribution did this research make? Or was the simulator unable to make specific predictions since it was incomplete? As about one year has elapsed since the test, can you make any remarks about the results or their interpretation? I do understand that you may not be able to talk about the results for reasons of confidentiality, but considering the fact that you are two years into Phase 2 according to the schedule, I get the impression from this paper that it started with a bang but ended in a whimper.

**Answer (Norio Tenma)**

The analysis results were used as basic data for designing the wells for the first offshore production test and for setting the monitoring wells. However, a range of verifications are being carried out using the data from the first offshore production test, and as mentioned in this paper, we are still in the process of data verification for constructing and analyzing the numerical model and laboratory experiments. Therefore, the paper is simply a report on the current status.

### 5 Significance of development of the simulator

**Comment (Hiroshi Tateishi)**

While I understand that the development of a simulator is a key pillar of this research, the role and significance of the

simulator is not clearly explained. Negatively speaking, I get the impression that the simulator development has become an end rather than a means. I think you should explain, in the early part of the paper, why the development of the simulator is necessary. Although it may be apparent to the people involved, it will not necessarily be clear to the general reader.

**Answer (Norio Tenma)**

To clarify the significance of the development of the geo-mechanical simulator, in chapter 1, "Introduction," I have added

the sentence, "it is therefore necessary to develop evaluation technologies, such as a numerical simulator, that are able to predict sediment deformation behavior " after "To enable safe and long-term gas production from the MH layer..." In relation, I added the sentence, "However, the basic characteristics that must be handled in a numerical simulator ... were not known at the start of the project, so we were unable to evaluate sediment deformation and consolidation."



# International standardization of four dimensional radiotherapy system

— Enhancement of effects of irradiation and assurance of safety —

Yuichi HIRATA<sup>1\*</sup>, Naoki MIYAMOTO<sup>1</sup>, Morihito SHIMIZU<sup>2</sup>, Mitsuhiro YOSHIDA<sup>3</sup>, Kazuo HIRAMOTO<sup>4</sup>, Yoshiaki ICHIKAWA<sup>5</sup>, Shuji KANEKO<sup>6</sup>, Tsuyoshi SASAGAWA<sup>7</sup>, Masahiro HIRAOKA<sup>8</sup> and Hiroki SHIRATO<sup>1</sup>

[Translation from *Synthesiology*, Vol.7, No.4, p.238-246 (2014)]

In radiation therapy for cancer, there are possibilities of position changes of the affected area during irradiation due to respiration of a patient. In order to enhance effects of irradiation for the affected area and minimize damages to the surrounding normal tissues, four dimensional radiotherapy (4DRT), which can take into account time variation of the three-dimensional position of the affected area, has been recently developed, and has been achieving significant therapeutic effects. We have proposed the International Electrotechnical Commission (IEC) standards including technical requirements of the safety aspects of the systems which realize this 4DRT, taking into account the time aspect. The reason for the proposal is that international standardization will be very effective to ensure safety of 4DRT, and international standards of IEC will have compelling force if regulatory agencies refer to them. The purpose of this paper is to summarize the analysis of the strategy in a precedent endeavor toward international standardization of the 4DRT systems, for which demands are increasing. The main point of the strategy is forming an international consensus by bringing together the opinions of specialists from various fields from a clinical point of view, focusing on the international standardization of the technical requirements of the safety aspects of the 4DRT. Based on such a strategy, we will promote developing new standards by evaluating the overall safety of the 4DRT systems for further expanding use, in addition to updating existing standards of particular equipment which constitute the 4DRT systems.

**Keywords :** Four dimensional radiotherapy, real-time tumor-tracking radiotherapy, dynamic tracking, international standardization, IEC

## 1 Introduction

### 1.1 Importance of radiation therapy

According to the annual estimated vital statistics of the Ministry of Health, Labour and Welfare for 2010,<sup>[1]</sup> cancer was the most common cause of death for the Japanese, and about 25 % of all patients were treated with radiation therapy. The radiation therapy is a medical treatment that utilizes the difference of radiation sensitivity between the tumor cells and normal cells, and destroys only the tumor cells without damaging the normal cells by controlling the quantity of therapeutic rays. The characteristic of radiation therapy is that it does not require surgery, can preserve the form and functions of the affected area, and has relatively short treatment time. Therefore, it is suitable for treatments of elderly people. In addition, it has the advantage that, in principle, it is capable of treating cancers in any region of the patient's body.

Figure 1 shows the trends of the number of individuals affected with cancer and the number of patients who are treated with radiation therapy. This figure was created based on the results of the structural survey by the Japanese

Society for Radiation Oncology (JASTRO) in 2010<sup>[2]</sup> and the estimated Japanese population-based cancer registration by the Center for Cancer Control and Information Services, National Cancer Center.<sup>[3]</sup> In the 1990s, the radiation therapy that used high-energy x-rays produced by small medical linear accelerators (LINAC) became widespread, and the number of its application increased, and this number is expected to grow. The rise in the death rate due to cancer is a trend seen in many aging countries, and there is a growing international need for radiation therapy.

### 1.2 Four-dimensional radiotherapy (4DRT)

In principal radiation therapies, x-rays, electrons, protons, and carbon are used as therapeutic rays. In any radiation therapy, the main issue is to irradiate the necessary quantity of therapeutic rays to the tumor that may move due to respiration or other factors and to minimize the damages to the surrounding normal tissues. To solve this problem, the R&D of 4DRT started around 2000 to enhance the timing accuracy of irradiation in addition to spatial accuracy.<sup>[4]</sup>

The 4DRT was employed around the world, and 4DRT was defined as “a therapy that explicitly includes the temporal

1. Hokkaido University Graduate School of Medicine North-15 West-7, Kita-ku, Sapporo 060-8638, Japan \* E-mail: hirata-yuichi@med.hokudai.ac.jp, 2. National Metrology Institute of Japan, AIST Tsukuba Central 2, 1-1-1 Umezono, Tsukuba 305-8568, Japan, 3. MITSUBISHI HEAVY INDUSTRIES, LTD. 4-6-22 Kan-on-shin-machi, Nishi-ku, Hiroshima 733-8553, Japan, 4. Hitachi, Ltd. 7-2-1 Omika-cho, Hitachi-shi 319-1221, Japan, 5. Hitachi, Ltd. Marunouchi Center Building, 1-6-1 Marunouchi, Chiyoda-ku 100-8220, Japan, 6. Kyoto University Hospital 54 Kawaharacho, Shogoin, Sakyo-ku, Kyoto 606-8507, Japan, 7. SHIMADZU CORPORATION 1 Nishinokyo-Kuwabaracho, Nakagyo-ku, Kyoto 604-8511, 8. Kyoto University Graduate School of Medicine Yoshida-Konoe-cho, Sakyo-ku, Kyoto 606-8501, Japan

changes of anatomy during the imaging, planning, and delivery of the radiotherapy.”<sup>[5]</sup> That is, 4DRT is a highly accurate radiotherapy that improves the dose concentration on tumors and minimizes damages to normal tissues, by taking into account the time variation of the position of the tumor against the irradiation timing, in addition to the three-dimensional position of tumors that has been considered in conventional radiotherapy. Recently, the applications of 4DRT have rapidly spread to tumors that move due to patient’s respiration and others.

Among the 4DRT methods, the Hokkaido University has been developing the gating radiotherapy (real-time tumor-tracking radiotherapy).<sup>[4][6]</sup> In the gating radiotherapy, as it will be explained below, the irradiation position of the therapeutic rays is fixed, and the irradiation is performed

in synch with the moving target. Here, accuracy of the irradiation timing of the therapeutic rays is important. Figure 2 shows the conceptual diagram of the gating radiotherapy, the therapy apparatus at the Hokkaido University, and the gold marker. In this method, the gold marker is implanted near the tumor position inside the patient’s body, and the x-ray image-guided radiation therapy (X-IGRT) equipment detects the gold marker that points to the position of the tumor that moves due to respiration. In the actual treatment, the external beam equipment irradiates the tumor with x-rays, protons, or others when the gold marker enters the region of the gating window. In cases in which this method was not used, the irradiation region had to be expanded to the entire region in which the tumor moved, and the surrounding normal tissues were irradiated with the same quantity as for the tumor position. The gating radiotherapy allowed the region of irradiation to be narrowed.

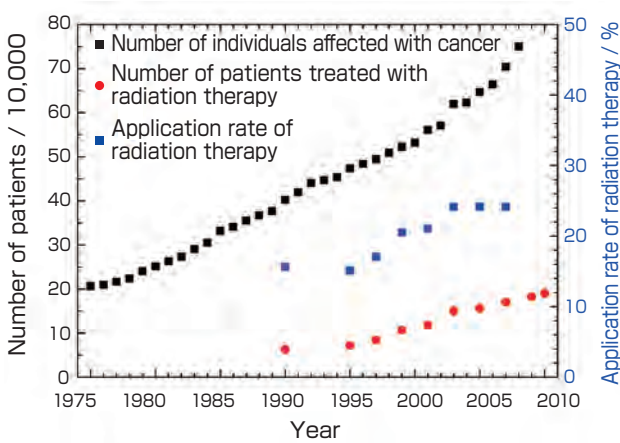

**Fig. 1 Transition of the number of patients who were newly diagnosed with cancer (number of individuals affected with cancer) in one year, and the number of patients who were treated with radiation therapy in the year**

Due to the penetration of the LINAC equipment, the number of patients who were treated with radiation therapy increased almost threefold in the last 20 years, and this number is expected to continue to increase.<sup>[2][3]</sup>

In contrast to the gating radiotherapy, the dynamic tracking radiotherapy places importance on the accuracy of the irradiation position of therapeutic rays in 4DRT.<sup>[8]</sup> As shown in Fig. 3, in the tracking radiotherapy, X-IGRT equipment tracks the position of the moving tumor using the markers, and the irradiation position of the therapeutic rays is controlled to ensure that the tumor is continuously irradiated with the therapeutic rays. The Kyoto University conducts the R&D for tracking radiotherapy using the external x-ray beam equipment that includes the ultra-compact LINAC developed by the Mitsubishi Heavy Industries, Ltd. The characteristic of the external x-ray beam equipment is that the ultra-compact LINAC is mounted inside the gantry along with the multi-leaf collimator (MLC) on the rotation mechanism called the gimbals mechanism, and this enables the irradiation direction of the therapeutic rays to be changed freely.<sup>[8]</sup> At the Kyoto University, the tracking radiotherapy is achieved by continuously tracking the tumor position inside the patient’s body and irradiating the tumor with therapeutic rays during treatment.

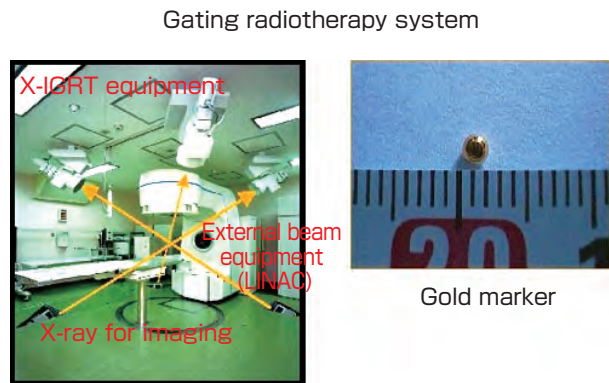
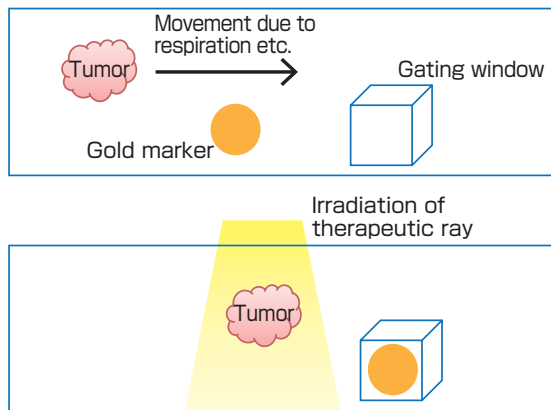

Source : [http://rad.med.hokudai.ac.jp/rad\\_research/motion\\_tracking/](http://rad.med.hokudai.ac.jp/rad_research/motion_tracking/)

**Fig. 2 Conceptual diagram of the gating radiotherapy (left), and photographs of the gating radiotherapy system and gold marker (right)**

Left photograph is cited from the website of the Hokkaido University Hospital.<sup>[7]</sup>

Although the 4DRT enables more effective therapy than the conventional radiotherapy, to perform the 4DRT safely, it is necessary to individually manage the parameters corresponding to tumor motions for each patient, since there is an increase in the number of parameters, including the timings of irradiation, the patterns of change in tumor position, the prediction model for predicting the change in tumor position, and others that are necessary to handle the degrees of freedom of tumor movement. In addition, the appropriate coordination of the X-IGRT equipment and external beam equipment that irradiates the tumor with x-rays, protons, or others is necessary to safely perform the radiation therapy.

As explained above, new safety requirements that were not considered before are necessary to realize the 4DRT. In the R&D for 4DRT, the most important aspect is safety assurance, and the safety requirements for 4DRT must be internationally standardized as soon as possible, to enable safe performance of 4DRT widely around the world. In addition, it can be expected that trial-and-error to ensure safety during the R&D of 4DRT can be reduced through the international standardization of the safety requirements for 4DRT.

Particularly, the arbitrary requirements that are internationally standardized by the International Electrotechnical Commission (IEC) are mandated and enforced, once they are quoted by the regulatory authority of a country. Therefore, the international standardization of the safety requirements of 4DRT system by the IEC is extremely effective to ensure solid safety assurance.

### 1.3 Organizations involved in the international standardization

There are three kinds of international standards: *de jure* standards that are developed by formal organizations; forum standards developed by private companies; and *de facto* standards that are developed through market competition (Intellectual Property Strategic Program 2011 of the Japanese

government).

Representative organizations that develop the *de jure* standards are International Organization for Standardization (ISO), International Electrotechnical Commission (IEC), and International Telecommunication Union (ITU). The radiotherapy equipment are handled in the electrotechnical field by the IEC, and the standardization of the X-IGRT equipment, an important component for realizing 4DRT, has recently progressed in the IEC.

In the IEC, the Technical Committees (TC) are organized by categories, and the international standards pertaining to radiotherapy equipment are discussed in TC62 that handles the electrical equipment for medical practice. The TC62 has four Subcommittees (SC) as subsidiary organizations, including the following: SC62A (Common aspects of electrical equipment used in medical practice), SC62B (Diagnostic imaging equipment), SC62C (Equipment for radiotherapy, nuclear medicine, and radiation dosimetry), and SC62D (Electromedical equipment). The international standardization of 4DRT will be discussed in SC62C that handles the radiotherapy equipment.

As shown in Fig. 4, the Japan Electronics and Information Technology Industries Association (JEITA) discusses the items related to TC62, SC62A, and SC62D of the IEC, as the Japanese national commission consigned by the IEC. Also, the Japan Medical Imaging and Radiological Systems Industries Association (JIRA)<sup>[10]</sup> discusses the items related to SC62B and SC62C of the IEC, as the Japanese national commission consigned by the IEC.

## 2 Objective of this paper

The objective of this paper is to analyze our case of the international standardization of 4DRT in the IEC, and to present a direction of how to promote its international standardization for expanding the international use of 4DRT

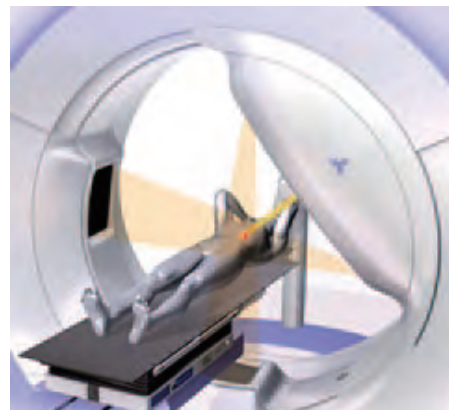
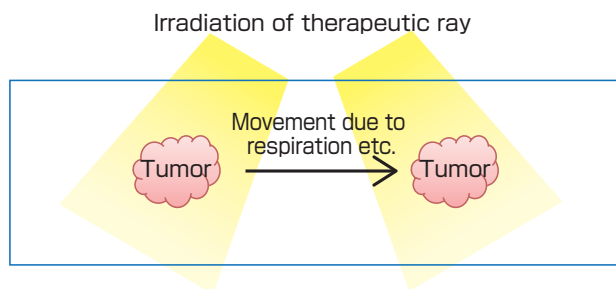

**Fig. 3 Conceptual diagram of the tracking radiotherapy (left), and photograph of the tracking radiotherapy system using Vero4DRT of Mitsubishi Heavy Industries, Ltd. (right)**

Left photograph is cited from the website of Mitsubishi Heavy Industries.

systems with enhanced safety.

### 3 Strategies for the international standardization of 4DRT

We planned to achieve the international standardization of the 4DRT system as a core in the IEC, the representative organization of *de jure* standards.

In order to resolve the general problems of international standardization<sup>[11]</sup> and the problems of international standardization in the field of radiotherapy equipment,<sup>[12]</sup> and to smoothly advance the international standardization of 4DRT, we adopted the following strategies.

#### 3.1 Selection of committee members from a wide range of fields

In addition to the private companies that engage in the production of 4DRT systems, the physicians and medical physicists involved in the clinical practice of 4DRT at universities and research institutes participated as members of the committee to propose the international standard. This allowed discussions of 4DRT from a wide range of fields in Japan.

#### 3.2 Ideas to facilitate the formation of international consensus

In contrast to the existing IEC standards that regulate the individual radiotherapy equipment, we proposed the standards for 4DRT systems by combining a number of individual equipment. We focused on the obvious problems that could not be solved by the standards for individual equipment, and we aimed for the international standardization of technologies related to safety for which consensus was relatively easy to obtain from the organizations working on international standards. In addition, we developed a universal phantom (object behaving in the same manner as human tissue with respect to absorption or scattering of the therapeutic rays; this is used to evaluate the performances of radiotherapy systems) that can be used to check the safety

of the 4DRT systems. We adopted the policy of creating the safety requirements based on concrete and objective data obtained from the phantom.

#### 3.3 International standardization initiated by users

In the system requirements, we listed the items that were considered clinically important by the users of the 4DRT systems. Then, we advocated the importance of system requirements from a clinical perspective to the experts of the IEC TC62/SC62C WG1 of which most affiliations were private companies.

### 4 Efforts for the international standardization

Based on the strategy explained in chapter 3, we developed the international standardization of 4DRT as follows.

#### 4.1 Clarification of the basic concept

In aiming for the international standardization of 4DRT, we considered the clarification of the basic concept of the international standardization as the most important topic, and discussed this matter in the Japanese national commission. 4DRT directly irradiates the moving tumor, minimizes the damages to the surrounding normal tissues, and reduces the patient's physical strain. In order to perform safe 4DRT, it is necessary for the equipment that constitute the 4DRT systems to be coordinated and integrated to function smoothly together during the treatment. Mere combinations of existing international standards cannot assure the appropriate and solid coordination of the various equipment necessary to realize the 4DRT systems. Therefore, we decided to propose a set of new safety requirements that are necessary for the appropriate and solid coordination of the 4DRT equipment. However, such basic concept was not set in the initial stages of activity for the international standardization of 4DRT. The basic concepts were developed to clarify the differences between the proposed international standard of 4DRT and the conventional IEC equipment standard in the processes of discussions at the IEC international conferences.

#### 4.2 Targets and required accuracy of 4DRT

4DRT is a technology that reduces the damages to the surrounding normal tissues in the radiotherapy for tumors that move due to respiratory motion. According to the definitions of the guidelines for respiratory motion management in radiation therapy<sup>[13][14]</sup> that were developed from a clinical point of view, the respiratory motion management may be applied only when the length of respiratory tumor motion exceeds 10 mm and the expansion of irradiation area required to compensate for the respiratory motion can be reduced to 5 mm or less in all directions, three dimensionally. From these definitions for respiratory motion management, we obtained the quantitative criteria for the length of target tumor motion (greater than 10 mm) and the reduction of the expansion of irradiation area compared with

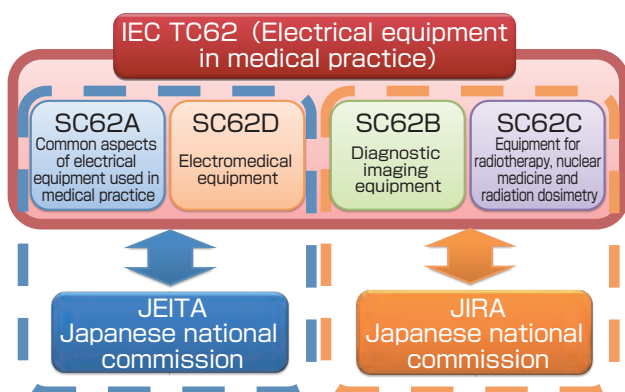

Fig. 4 Organizations involved in the international standardization of 4DRT

conventional radiotherapy (5 mm or less).

Specifically, as shown in Fig. 5, when the tumor moving due to respiration is treated with 4DRT, the irradiation area can be narrowed to 5 mm or less compared to the conventional radiotherapy.

**4.3 Items to be considered for 4DRT and its safety requirements**

In order to achieve the accuracy discussed in subchapter 4.2, we narrowed down the important 4DRT keywords that were not included in the existing IEC standards to “latency,” “prediction model,” “baseline shift,” “dynamic phantom,” and “4DCT.”

“Latency” is the time interval between the recognition of a tumor and the actual irradiation by the therapeutic rays on the patient’s body. If latency increases, the irradiated position of the therapeutic rays may deviate from the tumor position as shown in Table 1, and therefore, the prediction of tumor position is performed using a reliable prediction model.

For latency, we must consider the latency of the overall system that includes the X-IGRT equipment and the external

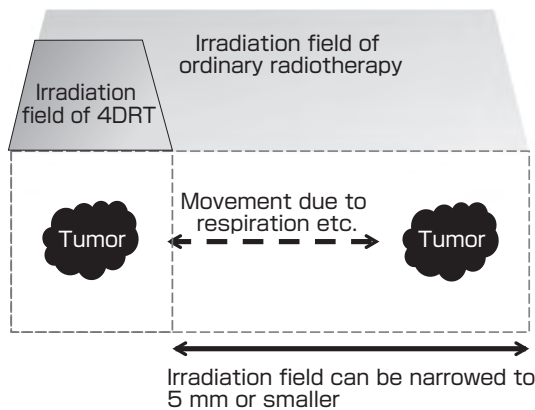

**Fig. 5 Comparison between the irradiation field of 4DRT and that of conventional radiotherapy**

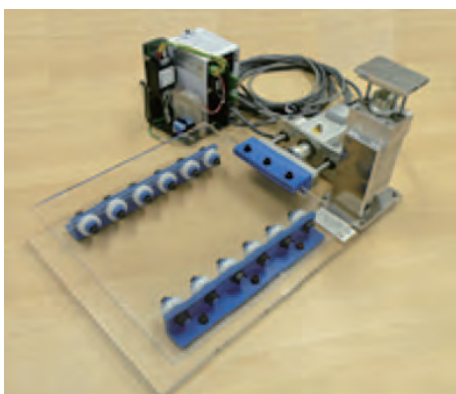

**Fig. 6 Photograph of the dynamic phantom**  
The dynamic phantom is used to evaluate the geometrical deviations of the X-IGRT equipment in 4DRT.

**Table 1. Maximum position deviation due to latency**

Calculated values of deviations between the tumor position and the irradiated position in cases where the tumor moves along the 2 cm distance in 3 sec cycle sinusoidal wave

It can be seen that the latency of about 250 msec causes a position deviation of 5 mm between the tumor position and the actual irradiated position.

Latency [msec]	Maximum position deviation due to latency [mm]
50	1.0
100	2.1
150	3.1
200	4.2
250	5.2

beam equipment to ensure the accuracy of irradiation of therapeutic rays. For example, the position deviation  $D$  in 4DRT for the tumor moving with mean velocity  $V$  can be considered as follows. Latency  $T$  of the overall system is the sum of the following times: the interval between the recognition of tumor position by a tumor-position-measuring equipment such as the X-IGRT equipment and the transmission of irradiation instructing signal to the therapeutic-ray-irradiating equipment ( $T_1$ ); the interval between the reception of irradiation instructing signal and the irradiation of therapeutic rays, change in beam direction, or other instructed action ( $T_2$ ); and the time required for communication ( $T_3$ ). The deviation of recognition of position by the IGRT equipment  $D_0$  is added to the final position deviation  $D$  that is represented by following formula:

$$D = V(T_1 + T_2 + T_3) + D_0 \quad (1)$$

That is,  $D$  represents the irradiation accuracy of the 4DRT systems, and it is dependent on a number of factors such as the latency of various equipment, the time of communication, and the deviation of recognition of position by the X-IGRT equipment. To assure the safety of overall 4DRT systems, we need not only the international standards for the various types of equipment ( $T_1$ ,  $T_2$ ,  $T_3$ , and  $D_0$ ), but also the international standards for the system at the level superior to the equipment ( $T$  and  $D$ ).

“Baseline shift” is the change of the patient’s respiration state that cannot be predicted by the prediction model. If the baseline shift is ignored, the tumor moving in a way that cannot be foreseen by the prediction model may be irradiated according to the model, and in such a case, the normal cells may be irradiated with the therapeutic rays. In cases in which the baseline shift occurs, a mechanism to definitely terminate the irradiation of therapeutic rays is necessary in the 4DRT systems.

“Dynamic phantom” is a model for simulating the tumor motions inside the patient’s body. This model is used to examine the performances of the 4DRT systems in terms of “latency,” “prediction model,” and “baseline shift.”

Finally, “4DCT” is a method for reconstructing the moving CT images by obtaining the x-ray CT images during, for example, five respirations and then using the markers placed on the surface of patient’s body. Since the information for tumor motion can be obtained using the 4DCT and the treatment plan for 4DRT can be created based on this information, the accuracy of 4DCT often becomes a problem in the 4DRT systems.

The above keywords are items that must be at least considered in the clinical practices of 4DRT, and they must be defined in the IEC standards.

#### **4.4 Introduction of the new concepts to the existing standards**

The above keywords play important roles in assuring the safety of 4DRT. Therefore, we set the required items that should be standardized based on the keywords, and proposed the safety standards for 4DRT in the IEC TC62/SC62C WG1 held in Germany on September 2011.

However, at that time, the basic concept of standardization of the 4DRT systems (refer to subchapter 4.1) was not clear, and we could not obtain the consensus to develop a completely new standard in the IEC TC62/SC62C WG1 to assure safety of 4DRT. Therefore, we reached the consensus to add the requirements related to 4DRT in the existing standard of the X-IGRT equipment (IEC 60601-2-68) that was being discussed in the IEC TC62/SC62C WG1, and we obtained results on the latency and the baseline shift as follows.

##### **4.4.1 Latency**

Regarding latency, the requirements of latency of the X-IGRT equipment (the time interval between the acquisition of images that includes the tumor position information and the outputting signal to external beam equipment ( $T_{\text{lat}}$ )) were added to the IEC 60601-2-68. This was because the importance of latency was recognized for the safety of the X-IGRT equipment.

##### **4.4.2 Baseline Shift**

Regarding the baseline shift that is expected to occur frequently during 4DRT, the requirements of the baseline shift were added to the standard of the X-IGRT equipment (IEC 60601-2-68), since we obtained consensus on the necessity of requirements by which the irradiation of therapeutic X-rays can be interrupted and settings of the equipment can be modified to continuously administer safe and smooth treatment.

##### **4.4.3 Correspondence to the existing standards**

In addition, we continued discussions in the IEC TC62/SC62C WG1 and obtained the following results corresponding to the existing standards (IEC 60601-2-68).

We found that the offline X-IGRT, online X-IGRT, and real-time X-IGRT 4DRT, which were defined in the IEC 60601-2-68, were all related to 4DRT. Therefore, we organized the above relationships and were able to add examples of the 4D versions of the offline X-IGRT, online X-IGRT, and real-time X-IGRT to the new annex of IEC 60601-2-68.

##### **4.4.4 Updating the standard for the external x-ray beam equipment**

The concept of latency is important for the external x-ray beam equipment that was the other component for realizing the 4DRT, and the above results for latency became a trigger for updating the safety standard of the external x-ray beam equipment (IEC 60601-2-1). In the update (62C/574/RR) of the standard for external x-ray beam equipment (IEC 60601-2-1), the item for motion management in 4DRT will almost certainly be added to the IEC 60601-2-1. In the item for motion management, gating and tracking irradiations that are representative methods of 4DRT as well as latency were listed. Particularly, the Japanese national commission was requested from the start to create the proposal for latency requirements at the IEC TC62/SC62C WG1. Since the standard for external x-ray beam equipment (IEC 60601-2-1) was the most basic and most important standard for assuring the safety of equipment for the radiotherapy equipment manufacturers, it was highly significant that the Japanese IEC experts could participate from the start in updating the standard.

##### **4.4.5 Items other than the latency and baseline shift**

Among the five items discussed in subchapter 4.3, we decided to fully develop three items (a prediction model, a dynamic phantom, and 4DCT) other than latency and baseline shift in the new work item proposal (NP) that will be proposed by Japan at the IEC, as they seemed to have high novelty.

## **5 Future direction**

To further contribute internationally in the standardization for the safety of treatment equipment in the future, it is necessary to engage in the international standardization activities as follows.

Internationally, there are examples where a large-scale company that specializes in radiotherapy systems independently takes a proactive stance for the international standardization of radiotherapy equipment. In addition to the activities that we have been conducting, it is essential to engage in vigorous international standardization activities through industry-academia-government collaboration. The companies developing

and producing the 4DRT systems, government agencies, public research organizations, universities, academic societies, and other interested parties must work together.

Based on the basic concept explained in subchapter 4.1, international standardization from the standpoint of system aspects is necessary.

The 4DRT system is a complex system comprised of several components such as the X-IGRT equipment that mainly monitors the tumor state, the external beam equipment that directly treats the tumor, the treatment table, and the treatment planning equipment that appropriately controls the equipment. On the other hand, since the international standardization and the creation of de facto standards are being done to integrate the above components of the 4DRT system, it is unrealistic to create completely new standards for these components. As a result, it is unclear where the responsibility lies in coordinating and connecting these components, and this creates concern for patient safety. If we overlook this point, it may cause medical accidents such as excessive or under irradiation.

Originally in the IEC TC62/SC62C, the main task was to create the standards for independent equipment, and therefore, the system standard was not created. To supplement this, the Japanese national commission proposed the NP (62C/580/NP) for creating a completely new system standard for the “Requirements of safety and performance of complex real-time controlled radiotherapy systems for a moving target,” and the NP was approved by international voting. In this NP, it is expected that the five items discussed in subchapter 4.3 will be officially standardized to assure the overall safety of the 4DRT systems.

In addition, it is becoming certain that the system will be included in the new scope proposal of the IEC TC62/SC62C, and the system standard of radiotherapy systems will be created in the IEC. Of course, in developing a completely new system standard, we must proceed with ingenuity to avoid disadvantages to individual companies. However, we shall promote the development of new system standards to ensure safety of radiotherapy that can track tumor motion, for both large and small companies.

In the future, it is expected that the international standardization of 4DRT in the IEC will be developed for both the independent equipment standard and the system standard as shown in Fig. 7.

## Acknowledgements

This research was supported by the R&D Program of International Standards, Ministry of Economy, Trade and Industry. The research was also supported by Associate

Professor Kenji Naoe and Associate Professor Takashi Kozuka of the Graduate School of Medicine, Hokkaido University, and the people of JIRA.

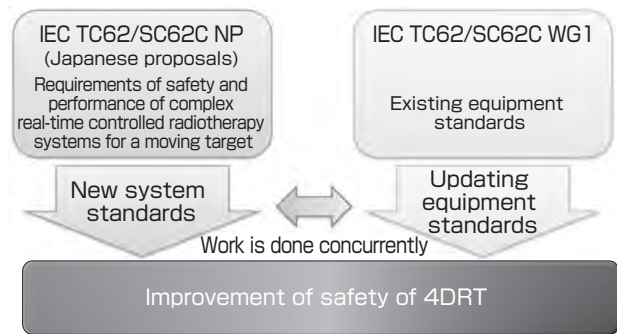

Fig. 7 Future direction of the international standardization of 4DRT

## References

- [1] Ministry of Health, Labour and Welfare: Vital statistics, <http://www.mhlw.go.jp/toukei/saikin/hw/jinkou/kakutei10/>
- [2] Japanese Radiation Oncology Data Center: Japanese Structure Survey of Radiation Oncology in 2010 (First Report) (in Japanese). <http://www.jastro.or.jp/aboutus/datacenter.php>
- [3] A. Matsuda, T. Matsuda, A. Shibata, K. Katanoda, T. Sobue, H. Nishimoto and The Japan Cancer Surveillance Research Group: Cancer incidence and incidence rates in Japan in 2007: a study of 21 population-based cancer registries for the Monitoring of Cancer Incidence in Japan (MCIJ) Project, *Jpn. J. of Clin. Oncol.*, 43 (3), 328-336 (2013).
- [4] H. Shirato, S. Shimizu, K. Kitamura, T. Nishioka, K. Kagei, S. Hashimoto, H. Aoyama, T. Kunieda, N. Shinohara, H. Dosaka-Akita and K. Miyasaka: Four-dimensional treatment planning and fluoroscopic real-time tumor tracking radiotherapy for moving tumor, *Int. J. Radiat. Oncol. Biol. Phys.*, 48 (2), 435-442 (2000).
- [5] P. J. Keall, A. D. Todor, S. S. Vadam, C. L. Barteel, J. V. Siebers, V. R. Kini and R. Mohan: On the use of EPID-based implanted marker tracking for 4D radiotherapy, *Med. Phys.*, 31 (12), 3492-3499 (2004).
- [6] S. Yamanaka and T. Sasagawa: Development of "SyncTraX" real-time tumor tracking system for Radiation Therapy, *Shimadzu Hyoron*, 70 (1•2), 41-48 (2013) (in Japanese).
- [7] [http://rad.med.hokudai.ac.jp/rad\\_research/motion\\_tracking/](http://rad.med.hokudai.ac.jp/rad_research/motion_tracking/)
- [8] Y. Kamino, K. Takayama, M. Kokubo, Y. Narita, E. Hirai, N. Kawawada, T. Mizowaki, Y. Nagata, T. Nishidai and M. Hiraoka: Development of a four-dimensional image-guided radiotherapy system with a gimbaled X-ray head, *Int. J. Radiat. Oncol. Biol. Phys.*, 66 (1), 271-278 (2006).
- [9] [http://www.mhi.co.jp/products/detail/vero\\_advanced\\_radiotherapy.html](http://www.mhi.co.jp/products/detail/vero_advanced_radiotherapy.html)
- [10] Standardization Division, Japan Medical Imaging and Radiological Systems Industries Association: Gazo iryo shisutemu no anzen kikaku no doko (Trends of safety standards for radiological systems), *Jpn J. Radiol. Technol.*, 66 (10), 1397-1401 (2010) (in Japanese).
- [11] Y. Ichikawa: Kokusai Hyojunka katsudo to gurobaru kankyo senryaku (International standardization activity and global environment strategy), *Hitachi Hyoron*, 93 (05-06), 12-16 (2011) (in Japanese).

- [12] Second Meeting IEC/TC62 Subcommittee FY 2011, Japan Electronics and Information Technology Industries Association, November 1, 2011 (in Japanese).
- [13] Japan Society of Medical Physics, Japan 3-D Conformal External beam Radiotherapy Group, Japanese Society of Radiological Technology, and Japanese Society for Radiation Oncology: Kokyusei ido taisaku o tomonau hoshasen chiryo ni kansuru gaidorain (Guideline for respiratory motion management in radiation therapy (June 2, 2012) (in Japanese).
- [14] Y. Matsuo, H. Onishi, K. Nakagawa, M. Nakamura, T. Arijji, Y. Kumazaki, M. Shimbo, N. Tohyama, T. Nishio, M. Okumura, H. Shirato and M. Hiraoka: Guidelines for respiratory motion management in radiation therapy, *J. Radiat. Res.*, 54 (3), 561-568 (2013).

## Authors

### Yuichi HIRATA

Completed the doctorate at the Department of Physics, Graduate School of Science, Hokkaido University in 2001. Doctor (Science). Worked at the Institute of Medical Science, The University of Tokyo; Riken; National Institutes of Health, USA; AIST; Tani & Abe, p.c.; and Project Assistant Professor, Graduate School of Medicine, Hokkaido University from August 2011 to present. In the international standardization activities for 4DRT, made essential contributions to overall organization of the activities, drafting of the 62C/580/NP standard proposal, organization of the standard proposal committees, proposal of the standardization strategy, and negotiation with the overseas members.



### Naoki MIYAMOTO

Completed the doctorate at the Department of Quantum Energy Engineering, Graduate School of Engineering, Hokkaido University in 2006. Doctor (Engineering). After working as post-doctoral researcher at the Graduate School of Engineering, Hokkaido University, became Project Assistant Professor, Graduate School of Medicine, Hokkaido University from April 2008 to present. In the international standardization activities for 4DRT, made essential contributions to R&D for the dynamic phantom and drafting of the 62C/580/NP standard proposal pertaining to dynamic phantom.



### Morihito SHIMIZU

Completed the doctorate program at the Department of Nuclear Engineering, Graduate School of Engineering, Kyoto University in 2001. Doctor (Engineering). Researcher, National Metrology Institute of Japan, AIST from April 2011 to present. In the international standardization activities for 4D radiotherapy, made essential contributions to creation of the revised Japanese standard proposal for external x-ray beam device (IEC60601-2-1).



### Mitsuhiro YOSHIDA

Graduated from the Department of Physics, Faculty of Science, Kyoto University in 1990. Joined the Advanced Technology Research Center, Mitsubishi Heavy Industries, Ltd. in 1990. Transferred to the Hiroshima R&D Center, MHI in 1996 and Hiroshima Machinery Works, MHI in 2004, and contributed to the development of industrial accelerators. Dispatched to the Biomedicine Division, NEDO in 2006; Section Chief, Vacuum Device Technology Section, Hiroshima Machinery Works, MHI in 2008; and started work in radiotherapy equipment from 2010. In the international standardization activities for 4D radiotherapy, made essential contributions to creation of the standard proposal for X-IGRT (IEC 60601-2-68), creation of the revised Japanese standard proposal for external x-ray beam device (IEC 60601-2-1), creation of the 62C/580/NP standard proposal, proposal of the standardization strategy, and negotiation with the overseas members.



### Kazuo HIRAMOTO

Completed the master's course at the Department of Electrical Engineering, Graduate School of Engineering, Kyoto University in 1978. Obtained doctorate (Kyoto University) in 1986. Joined the Energy Research Laboratory, Hitachi, Ltd. in 1978. After R&D of nuclear reactor core and particle radiotherapy accelerator, became Leader of R&D Group from 2012. In the international standardization activities for 4D radiotherapy, made essential contributions to creation of the standard proposal for X-IGRT (IEC 60601-2-68), creation of the revised Japanese standard proposal for external x-ray beam device (IEC 60601-2-1), creation of the 62C/580/NP standard proposal, proposal of the standardization strategy, and negotiation with the overseas members.



### Yoshiaki ICHIKAWA

Graduated from the Department of Mechanical Engineering, Faculty of Engineering, The University of Tokyo in 1979, obtained doctorate in engineering (Tokyo University) in 1987. Joined the Energy Research Laboratory, Hitachi, Ltd. in 1979. Visiting Scientist, Carnegie Mellon University in 1988; Director, Environment Solution Center, Hitachi, Ltd.; Environmental Strategy Office, Hitachi, Ltd.; and currently, Senior Engineer, International Standardization Promotion Office, Intellectual Property Headquarters, Hitachi, Ltd. In the international standardization activities for 4D radiotherapy, made essential contributions to creation of the standard proposal for X-IGRT (IEC 60601-2-68), creation of the revised Japanese standard proposal for external x-ray beam device (IEC 60601-2-1), creation of the 62C/580/NP standard proposal, proposal of the standardization strategy, and negotiation with the overseas members.



### Shuji KANEKO

Graduated from the Department of Control Engineering, Tokyo Institute of Technology in 1994. Joined Mitsubishi Heavy Industries, Ltd. in 1994. In charge of systems development and marketing for radiotherapy equipment



from 2004. Project-Specific Lecturer, Kyoto University Hospital from 2011 to present. In the R&D for motion-tracking radiotherapy and the international standardization activities for 4DRT, made essential contributions to creation of the standard proposal for X-IGRT (IEC 60601-2-68), creation of the revised Japanese standard proposal for external x-ray beam device (IEC 60601-2-1), creation of the 62C/580/NP standard proposal pertaining to motion-tracking radiotherapy, proposal of the standardization strategy, and negotiation with the overseas members.



#### **Tsuyoshi SASAGAWA**

Graduated from the Department of Mathematics, Faculty of Science and Engineering, Waseda University in 1990. Joined the Shimadzu Corp in 1990. In the international standardization activities for 4D radiotherapy, made essential contributions to creation of the standard proposal for X-IGRT (IEC 60601-2-68), creation of the revised Japanese standard proposal for external x-ray beam device (IEC 60601-2-1), creation of the 62C/580/NP standard proposal, proposal of the standardization strategy, and negotiation with the overseas members.



#### **Masahiro HIRAOKA**

Graduated from the Faculty of Medicine, Kyoto University in 1977. After working at the Radiotherapy Seminar, Kyoto University; Stanford University; and others, became Professor of Radiotherapy Lectures, Graduate School of Medicine, Kyoto University in 1995. After working as Unit Leader, Nano-Medicine Merger Education Unit, Kyoto University; Director, Kyoto University Cancer Center; currently works as Deputy Director, Office of Society-Academia Collaboration for Innovation, Kyoto University. In the R&D for motion-tracking radiotherapy and the international standardization activities for 4D radiotherapy, made essential contributions to the creation of the standard proposal for X-IGRT (IEC 60601-2-68), creation of the revised Japanese standard proposal for external x-ray beam device (IEC 60601-2-1), creation of the 62C/580/NP standard proposal pertaining to motion-tracking radiotherapy, proposal of the standardization strategy, and negotiation with the overseas members.



#### **Hiroki Shirato**

Graduated from the School of Medicine, Hokkaido University in 1981. Worked at the Radiotherapy Division, Hokkaido University Hospital; University of British Columbia; Christie Hospital and University of Manchester; Head Physician, Radiology Department, Obihiro Kosei General Hospital; and Professor, Radiotherapy Department, Graduate School of Medicine, Hokkaido University in 2006. Appointed as Assistant Planner and Manager, Office of the President, Hokkaido University. Currently, Member of Board of Directors, Graduate School, Hokkaido University, as well



as Deputy Director, Graduate School of Medicine, Hokkaido University. In the R&D for motion-tracking radiotherapy and the international standardization activities for 4D radiotherapy, made essential contributions to the creation of the standard proposal for X-IGRT (IEC 60601-2-68), creation of the revised Japanese standard proposal for external x-ray beam device (IEC 60601-2-1), creation of the 62C/580/NP standard proposal pertaining to motion-tracking radiotherapy, proposal of the standardization strategy, and negotiation with the overseas members.

## **Discussions with Reviewers**

### **1 Overall comment**

#### **Comment (Akira Ono, AIST)**

This paper clearly illustrates the strategy and results for creating an international standard for 4DRT that was led by Japanese academia and industries. It specifically describes the process by which the draft of the standard was submitted to the IEC. It may lead to updating of existing standards of the IEC or new standards in the future. Also, the Japanese system for drafting the proposal is well described. This would be useful to the readers who plan to become involved in international standardization in the future. I think it is an excellent paper for *Synthesiology*.

### **2 Significance of international standardization**

#### **Question (Motoyuki Akamatsu, Human Technology Research Institute, AIST)**

The motivation for research is written in subchapter 1.2, and it states the social value of this paper. Needless to say, assurance of safety is important, but you state that the international standardization of safety standards is needed as the means to achieve safety. Generally, I feel there are ways to provide safety without such international standardization. Therefore, can you explain why international standardization will ensure safety?

#### **Answer (Yuichi Hirata)**

Specifically, the arbitrary requirements that are internationally standardized by the IEC are mandated and enforced, once they are quoted by the regulatory authority of a country. Therefore, international standardization of the safety requirements of 4DRT system by the IEC is extremely effective to achieve solid safety assurance.

### **3 Agreement among a wide range of stakeholders**

#### **Comment (Akira Ono)**

In the process of standardization, the central point is to make an agreement among a wide range of stakeholders involved. In the standardization at the ISO or IEC, since the participating countries may not necessarily have a wide range of stakeholders in their respective countries, the range of agreement could be narrow, which may not make standards widely used after publication.

In contrast, in the standardization of the 4DRT equipment discussed in this paper, its characteristic is that wide-ranging stakeholders in Japan were involved. The statements in subchapter 3.3 "International standardization initiated by users" and chapter 5 "Future direction" are appropriate. I think the wide participation of not only the radiotherapy equipment manufacturers but also the equipment users such as physicians, medical technicians, as well as researchers who maintain neutral positions led to the creation of a convincing standard with excellent neutrality. I expect this standard to be adopted worldwide.

#### **Answer (Yuichi Hirata)**

As you indicate, the participation of a wide range of Japanese stakeholders to create the WG for international standardization strategy for 4DRT, and the creation of a standard proposal based on the comments of people from various fields, including equipment manufacturers, physicians, medical physicists, researchers, and government agencies led to the standardization of 4DRT as explained in this paper.

#### **4 Is this a product standard or a test standard?**

##### **Question (Akira Ono)**

I ask you about the target range of the standard (or the scope of the standard) that Japan attempts to propose in the future. While it is addressed in subchapter 4.2 as well as in chapter 5 “Future direction,” which of (1) or (2) below is the target range of the standard that the authors assume? Or does it encompass both?

(1) Product standard: Are you trying to specify performance or function required for 4DRT? That is, are you trying to create a “product standard” for the 4DRT equipment?

(2) Test method standard: Are you trying to specify necessary

items and methods to test the 4DRT? That is, are you trying to create a “test method standard” for the 4DRT equipment?

As a personal opinion, if you are assuming development of a test method standard as in (2), I think you can clearly differentiate between a piece of equipment for which thorough safety considerations have been done and one that haven't. Also, the user can clearly recognize highly safe equipment by investigating whether it matches this standard. Therefore, this standard is advantageous to the users around the world, and at the same time, I think the equipment with solidly enhanced safety will be evaluated highly.

##### **Answer (Yuichi Hirata)**

The specific target range of the standard in the future will encompass both (1) and (2) that you described. For (1), I think the necessary performance and functions are standardized based on the 4DRT systems that currently exist on the market. For (2), I think, for example, the evaluation test method for 4DRT using the dynamic phantom will be standardized.

# Preparation of superconducting films by metal organic deposition

— Research and development towards a fault current limiter and  
other electric devices —

Takaaki MANABE\*, Mitsugu SOHMA, Iwao YAMAGUCHI, Hiroaki MATSUI, Tetsuo TSUCHIYA and Toshiya KUMAGAI

[Translation from *Synthesiology*, Vol.7, No.4, p.247-257 (2014)]

For the application of oxide superconductors to power-electric and microwave devices, it is necessary to form oxide superconductors into films and tapes. Since oxide superconductors are fragile and processing resistant, establishing a thin film processing technology for oxide superconductors is important. In this article, we describe our approach to developing such technology with an example that involves the processing of high quality large-size superconducting thin films by metal organic deposition (MOD) for the realization of a fault current limiter. MOD is a simple and low-cost processing technology for metal oxide thin films, which are prepared by dipping a substrate in a coating solution and firing the substrate.

**Keywords** : Metal organic deposition, superconductor, thin films, fault current limiter, microwave devices, coated conductor

## 1 Background of the research

### 1.1 High-temperature oxide superconductor and its application to a fault current limiter (FCL)

The high-temperature oxide superconductor that was discovered in 1986 was later found that its critical temperature (temperature at which superconductive condition is achieved and the electrical resistance is zero:  $T_c$ ) can be increased to 90 K with the discovery of perovskite-type compound  $\text{YBa}_2\text{Cu}_3\text{O}_7$  (hereinafter will be called YBCO), and the expectation for its practical application rose since it can be used with low-cost liquid nitrogen (boiling point 77 K) instead of expensive liquid helium (boiling point 4 K). For example, if this material is processed into power transmission cables, the loss due to resistance during power transmission can be reduced, and it was calculated that the transmission loss can be kept at about half compared to copper wire even considering the energy needed for cooling.<sup>[1]</sup>

Various applications and devices, not just power transmission cables, can be realized by processing the superconductor into thin film form. One such device is the SN transition type (thin film type) fault current limiter (FCL). As it will be explained in chapter 2, FCL is a new kind of electrical device that instantly inhibits large overcurrent that may occur due to lightning strikes or tree falls on the transmission or distribution lines, thus facilitating the shutoff of accidental current (Fig. 1).<sup>[1][2]</sup> Since the thin film type FCL (Fig. 2) is highly reliable and is capable of handling high voltage and large current, there is expectation for development toward

high-volume interconnection of distributed power supply sites using low-cost superconducting film.

### 1.2 Metal organic deposition (MOD) method

The authors had been engaging in the development of ceramic thin film manufacturing process by the metal organic deposition (MOD) method before the discovery of high-temperature superconductors. MOD is a method of “coating and firing” where the metal organic compound containing the constituent elements are dissolved in an organic solvent, this solution is coated onto a substrate, and heat treatment is done to burn off the organic components to form the metal oxide film (Fig. 3).<sup>[3][4]</sup>

Since the MOD method is comprised of simple processes of “coating and firing” and does not require a large-scale device that produces high vacuum or high voltage, it has the following characteristics: (1) it is easy to accurately control the chemical composition of the film, (2) it uses relatively low temperature in the process, (3) it can be applied to large surface area substrates of various forms as well as tapes of long length, and (4) it has low environmental load since it emits only steam and carbon dioxide during complete combustion and does not emit harmful substances such as hydrogen fluoride as in the MOD method that uses metal trifluoroacetates as a raw material (TFA-MOD).<sup>[5]</sup>

This paper describes the approaches and methods that were employed to achieve the goal for meeting the product requirement. The technology was developed to create a high-

---

Advanced Manufacturing Research Institute, AIST Tsukuba Central 5, 1-1-1 Higashi, Tsukuba 305-8565, Japan

\* E-mail: manabe.t@aist.go.jp

Original manuscript received June 6, 2014, Revisions received July 25, 2014, Accepted August 11, 2014

quality large-surface-area superconducting film using the MOD method for application to FCL, under “R&D of the Core Technology for Superconducting AC Equipment”<sup>[1]</sup> funded for the Technological Development for Diversification of Power Source of the New Energy and Industrial Technology Development Organization (NEDO) and others.

## 2 Necessity for device against accidental current such as FCL, and the required specification for the superconducting film in the thin film type FCL

It was mentioned in the previous chapter that one of the applications of the superconducting thin film is to the

thin film resistive-type FCL. To meet the demands of electric power deregulation and power shortage, the grid interconnection is promoted in which the distributed power supply such as excess power from home generated sources are connected and operated using the distribution lines of the electric power companies. When the distributed power supply sites are connected, in cases of short-circuit accidents as shown in Fig. 1(a), large overcurrent (accidental current or fault current) flows through the grid system instantly, and this may cause whole area blackout, damage the distributed power generators, and harm power appliances. To avoid such accidental damages, expensive additions must be made to facilities such as changing the existing distribution lines and

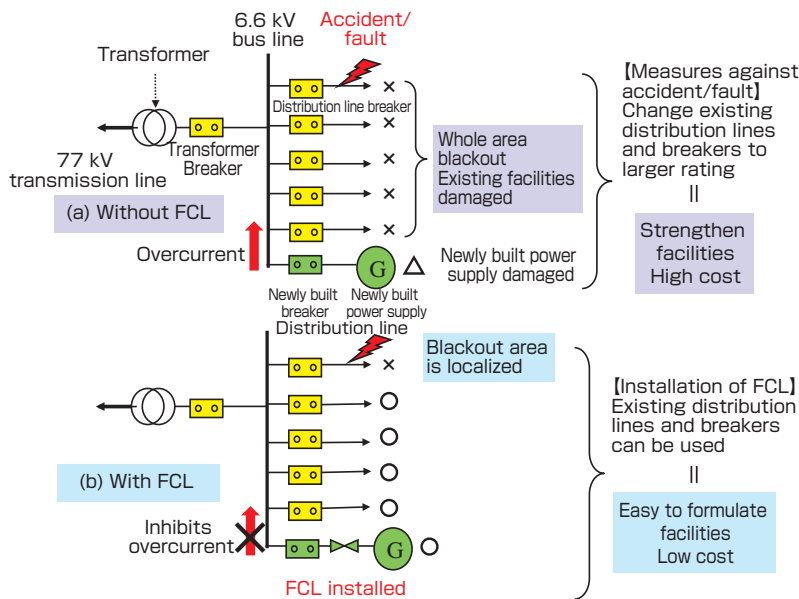

Fig. 1 Installation of FCL in distributed power supply site

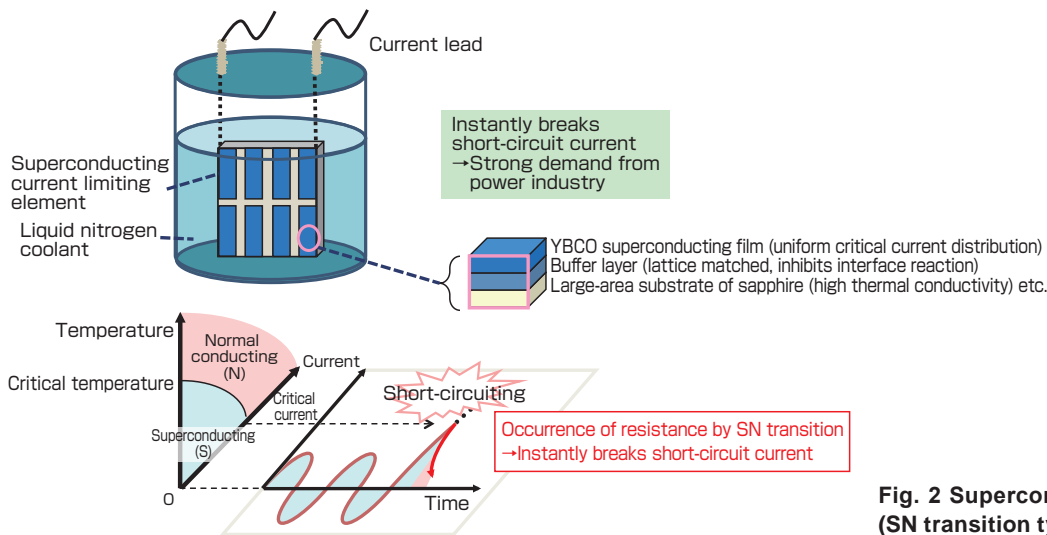

Fig. 2 Superconducting thin film FCL (SN transition type)

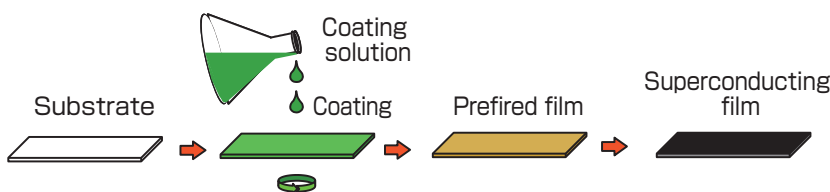

Fig. 3 Metal organic deposition (MOD) method

breakers to ones with larger ratings. In contrast, when FCLs are introduced as shown in Fig. 1(b), the existing distribution lines and breakers can be used and the facilities can be laid out readily. Therefore, the realization of such FCLs is eagerly awaited.<sup>[1]</sup> Here, FCL is a device that inhibits the overcurrent to flow into the circuit to protect the power network system (distribution and main lines) from fault current.

Currently, passive (autonomous action) FCLs including the thin film resistive-type and rectifier-type, as well as active FCLs such as the semiconductor switch type and arc driven type are being developed. The thin film resistive-type FCL (Fig. 2) is a type of passive FCL that uses the phenomenon where the superconducting thin film changes instantly from superconducting to normal conducting states and large resistance is generated when the overcurrent flows through the superconducting thin film (this phenomenon is called the SN transition or quenching) to inhibit the fault current.<sup>[6]</sup> Since there are no moving parts in this method, it is reliable compared to active FCLs. Since the series-parallel arrangement of superconducting film is capable of handling high voltage and large current, there is expectation for the application to high-volume interconnection of distributed power supply sites using the low-cost superconducting film.

The functions required for the superconducting film for thin film resistive-type FCLs are as follows.

(1) Large critical current (current can flow in the superconducting state)

→ Critical current density ( $J_c$ : hereinafter, critical current per 1 cm<sup>2</sup> of cross section at 77 K) must be high and the thin film be wide

(2) When it shifts to a normal conducting state, it must have high resistance and produce high voltage

→ Thin film must be long in the direction of the current

The width and length of the superconducting film are related to the current and voltage, respectively, and the loss by the number of steps to obtain series-parallel arrangement and connection resistance increases as the number of sheets of superconducting film increases. Therefore, a superconducting film with high  $J_c$  and a large surface area is necessary. The developmental goals of the “R&D of the Core Technology for Superconducting AC Equipment” funded for the Technological Development for Diversification of Power Source were as follows:<sup>[7]</sup>

- High critical current density ( $J_c > 1,000,000$  A/cm<sup>2</sup>)
- A large surface area (10 cm × 30 cm)

Here, the  $J_c$  value of the superconducting film is strongly dependent on the microstructure of the thin film, and it is necessary to have a single-crystal film where the YBCO particles are arranged three dimensionally to achieve high  $J_c$ . Therefore, it is necessary to manufacture a single-crystal superconducting thin film using the single-crystal with

good lattice match (small difference of lattice constant) with YBCO as a substrate, and then epitaxially grow the YBCO on such a substrate. As it will be mentioned later, the sapphire (single-crystal alumina) substrate is highly regarded as the substrate for superconducting film for FCL from the perspective of thermal shock resistance and thermal conductivity. The largest size of commercially available sapphire was 10 cm × 30 cm. Since sapphire has poor lattice match with YBCO (about 10 % mismatch) and reacts with YBCO at high temperature, it is necessary to form an appropriate buffer layer between the two. Also, the superconducting film must be thick to increase the critical current, but the thermal expansion coefficient of YBCO ( $13 \times 10^{-6}/\text{K}$ ) is about twice that of sapphire ( $5\sim 7 \times 10^{-6}/\text{K}$ ).<sup>[8][9]</sup> When the film thickness of YBCO surpasses 300 nm (critical film thickness), micro-cracks may occur due to heat stress when cooling from the deposition temperature (700~800 °C), and therefore, the film thickness that can be obtained with sapphire is 300 nm or less.

### 3 Comparison of the MOD method and conventional large-area deposition technology and the scenario to realize the goal

As it is clear from chapter 2, the establishment of synthesis technology for large-area superconducting films with high  $J_c$  is necessary for the development of thin film resistive-type FCLs. Meanwhile, the authors have been engaging in the research of a YBCO thin film preparation process using the MOD method immediately after the discovery of YBCO. In this chapter, we shall describe the R&D scenario to achieve the goal for the product requirement extracted in chapter 2, when preparing the large-area superconducting film by the MOD method for FCL application, after comparing the MOD and the conventional large-area deposition technologies.

#### 3.1 Comparison of the MOD method and other large-area deposition technologies<sup>[3][4]</sup>

As shown in Fig. 3, the MOD method and the conventional large-area deposition technologies for metal oxides can be compared as follows.

1) Conventional technology

(1) Gas phase method (vacuum evaporation, pulsed laser deposition (PLD), sputtering, and chemical vapor deposition): The component atoms (molecules) are dissociated in the gaseous phase and then deposited on a substrate. Dense and good quality epitaxial film can be manufactured.

(2) Liquid phase method (slurry coating, sol-gel): The slurry, in which the powder of the target substance is dispersed in a solvent or a sol where a metal alkoxide is hydrolytically polycondensed, is coated onto a substrate, dried, and fired to manufacture a ceramic film.

2) Problems of the conventional method

- (1) The gas phase method requires the simultaneous control of the processes of gas production and deposition on the substrate, and therefore, controlling the composition and achieving large surface areas are difficult. Also, since high vacuum and high voltage are necessary, expensive facilities and a large amount of power are required, thus making the process costly and energy consuming.
- (2) As powder or gel formed by drying sol is fired, the liquid phase method results in a polycrystalline, non-oriented film with low performance.

It is possible to obtain an epitaxial film with high  $J_c$  by the gas phase method, but it is expensive and may generate non-uniformity in a large surface area. Conventionally, the maximum size of a YBCO film manufactured by the gas phase method is: 20 cm in diameter (with a non-deposited area in the center) and 10 cm × 20 cm (substrate transfer in one direction) by co-evaporation,<sup>[10]</sup> 7 cm × 20 cm by PLD,<sup>[12]</sup> and 7 cm in diameter by sputtering.<sup>[13]</sup> On the other hand, the liquid phase method enables the production of a low-cost, uniform, large-area film, but it will be polycrystalline, non-oriented, and have low  $J_c$ .

**3.2 Scenario to achieve the goal**

In this study, R&D was conducted using a scenario divided into the following two stages to achieve the goal to fulfill the product requirement extracted in chapter 2.

- I. Demonstration of YBCO thin film manufacturing and achievement of high  $J_c$
- II. Deposition of a high- $J_c$  large-area YBCO film

When discussing the research of the superconducting film deposition by the MOD method in chronological order, initially only Scenario I was the goal of development. There was fierce international competition to develop the superconducting film deposition technology by a solution method immediately after the discovery of the YBCO superconductor. The authors were able to demonstrate the zero resistance of the YBCO film ahead of other research institutions and were able to file the patent. Immediately after the discovery of the YBCO superconductor, development in Josephson elements for thin film application and superconducting wire rods, coils, magnets, and others in the

thick film application were discussed, but the achievement of high  $J_c$  ( $>1\,000,000\text{ A/cm}^2$ ) was required in all these applications. Figure 4 shows the diagram of the research scenario at this point.

When the firing temperature is high, a chemical reaction occurs at the interface between the YBCO film and the substrate, and therefore a low-temperature process was developed to inhibit this interface reaction. Then, a lattice-matched substrate that became available due to low-processing temperature was used to increase the orientation capability of the YBCO film, epitaxial film was formed unexpectedly even though it was through a solution method, and high  $J_c$  was obtained. The outline of this process will be discussed in the next chapter.

When it became apparent that the epitaxial YBCO film could be manufactured in Scenario I, the talks began of power deregulation and large-volume interconnection of distributed power supply sites. Since the superconducting film FCL became hopeful in strengthening the durability of the electrical devices for high-volume interconnection of dispersed power at low cost, the core technology for “epitaxial YBCO deposition and achievement of high  $J_c$ ” obtained in Scenario I was expanded to set Scenario II. However, many difficulties were predicted in manufacturing the large-area YBCO film with high  $J_c$  all at once, and the R&D was done concurrently to achieve the goals of II-1 and II-2 as follows. Ultimately, Goal II-3 would be achieved to fulfill the product requirement extracted in chapter 2.

- II-1 Achievement of large-area YBCO deposition on lattice-matched substrates
- II-2 Multilayer deposition of buffer and superconducting layers on sapphire (lattice-mismatched) substrates
- II-3 Manufacture of a large-area film with superconducting/buffer/sapphire multilayers

This scenario is shown in Fig. 5 and the outline will be explained in chapter 5. Table 1 shows the outlines of the elemental technologies that were necessary to achieve the goals in Scenario I and II for manufacturing the superconducting film, and the elemental technologies that played a major role in achieving the goals are framed by thick lines.

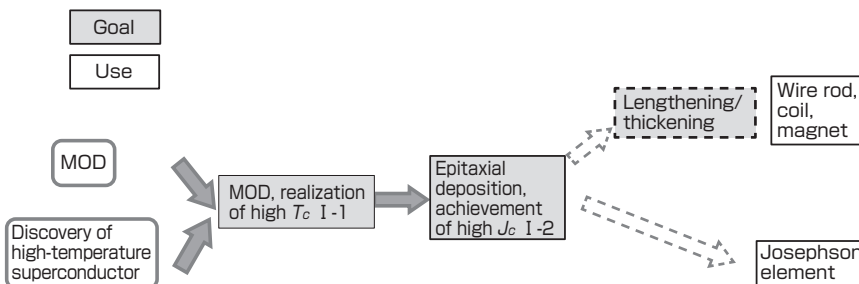

**Fig. 4 Scenario I for the manufacture of high- $J_c$  superconducting film by MOD**

**Table 1. Elemental technologies to achieve the goals in Scenario I and II for the manufacture of superconducting film**

GOAL	SUBSTRATE, TYPE, SIZE	BUFFER LAYER	SOLUTION	COATING	PREFIRING	FINAL HEAT TREATMENT	USE
I -1 : MOD, realization of high $T_c$	Selection of low-reactive substrate · YSZ · 12 mm $\phi$ , 25x25 mm <sup>2</sup>	—	Search of raw material and solvent	Dip coating	Thermal decomposition	Search of heat treatment condition in oxygen	
I -2 : Achievement of high $J_c$	Lattice-matched single crystal · STO · 5x10 mm <sup>2</sup>	—	Solution tuning	Spin coating	Thermal decomposition	Development of low-oxygen low-temperature process	(Josephson element)
II -1 : Primary achievement of large surface area	Large-area lattice-matched single crystal · STO, LAO · 2 cm $\phi$ , 5 cm $\phi$		Solution tuning	Spin coating	Thermal decomposition	Low-oxygen low-temperature process (infrared heating)	
II -2 : Consideration of multilayer process	Lattice-mismatched single crystal · sapphire · 2x2 cm <sup>2</sup>	CeO <sub>2</sub> vapor deposition	Solution tuning	Spin coating	Thermal decomposition	Low-oxygen low-temperature process (tubular furnace)	
II -3 : Achievement of large-area multilayer	Large-area lattice-mismatched single crystal · sapphire · 1x12 cm <sup>2</sup> , 3x21 cm <sup>2</sup> , 10x30 cm <sup>2</sup>	Large-area CeO <sub>2</sub> vapor deposition	Solution tuning	Large-area spin coating	Thermal decomposition	Low-oxygen low-temperature process (large-area tubular furnace)	FCL
II -4 : Achievement of low $R_s$ , patterning	Low permittivity substrate · LAO, LSAT · sapphire 2x2 cm <sup>2</sup> , 5 cm $\phi$	[CeO <sub>2</sub> vapor deposition]	Solution tuning	Spin coating	Irradiation · thermal decomposition (ELAMOD)	Low-oxygen low-temperature process	Microwave filter
II -5 : Lengthening/thickening, Achievement of high $I_c$	Textured metal · Ni-W etc. 1 cm width	CeO <sub>2</sub> vapor deposition	Coating solution for thick films, flux pinning	Dip coating etc.	Irradiation · thermal decomposition (ELAMOD)?	Low-oxygen low-temperature process	Wire rod

#### 4 Demonstration of YBCO thin film manufacturing and achievement of high $J_c$

In this chapter, the outline for achieving the high  $J_c$  in Scenario I shown in Fig. 4 will be explained.

##### 4.1 Preparation of the solution and the demonstration of YBCO deposition by heat treatment in oxygen

As shown in Table 1, to achieve Goal I-1, the search for starting materials and solvents for the coating solution, the pursuit of heat treatment conditions, and the selection of low-reactive substrates were the major developmental elements.

In general, the metal organic compounds with different electronegativity tend to have different solubility, and it is difficult to prepare a homogeneous solution in a multicomponent system. In this research, solvent search was conducted using

the organic compounds with characteristic structures (ones with side chains or acting as ligands) as starting materials and changing the types of solvents (hydrocarbon, alcohol, acid, ketone, aldehyde, ester, and nitrogen compounds) or their chain lengths. As a result, we were able to create a coating solution in which the Y, Ba, and Cu were homogeneously dissolved in high concentration. This solution was applied to the substrate, thermally decomposed at 500 °C in an ambient atmosphere to form a prefired film composed of Y<sub>2</sub>O<sub>3</sub>-BaCO<sub>3</sub>-CuO. The final heat treatment and solid-phase reaction were done at 950 °C in oxygen as in the sintered compact, and we succeeded in demonstrating the YBCO film preparation<sup>[14][15]</sup> and obtained the basic patent for the solution and the manufacturing method. However, since the final heat treatment temperature was high, we were unable to obtain a YBCO film on the lattice-matched single-crystal substrates with a perovskite structure such as strontium titanate (SrTiO<sub>3</sub>, lattice mismatch: about 1 %) since

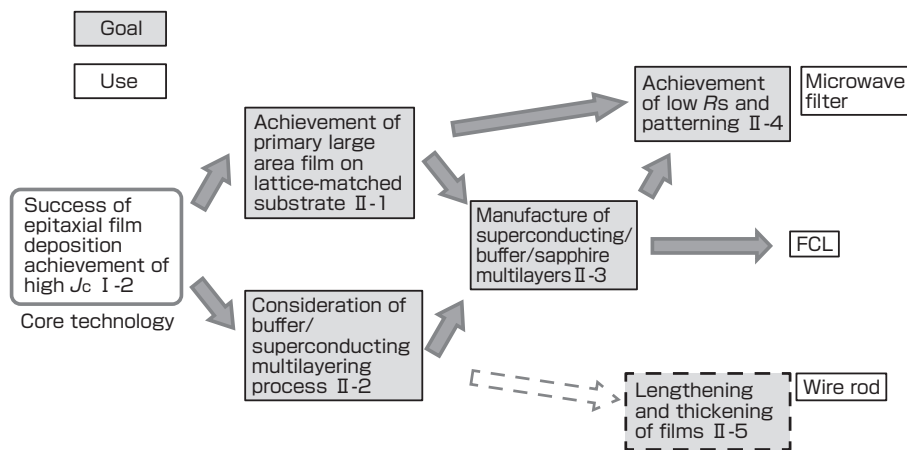

**Fig. 5 Scenario II for the manufacture of large-area superconducting film for FCL**

it reacted with BaCO<sub>3</sub> in the prefired film. We obtained  $T_c = 90$  K only when the yttria-stabilized zirconia sintered compact with low reactivity was used as the substrate, but the film was polycrystalline, and the  $J_c$  at liquid nitrogen temperature (77 K) was low ( $\sim 1000$  A/cm<sup>2</sup>).<sup>[16]</sup>

#### 4.2 Development of a low-temperature process and achievement of high $J_c$

The development of a low-temperature process using low-oxygen pressure was the most important point in achieving Goal I-2.

Since the superconductivity is lost when the high-temperature oxide superconductor is deprived of oxygen, it was conventionally fired in oxygen. The authors obtained the hint from the study by Kishio *et al.*,<sup>[17]</sup> and considered that the valence control of functional oxides that contain transition metals such as YBCO was important, and heat treatment must be done by controlling the oxygen partial pressure ( $pO_2$ ) and temperature ( $T$ ). Therefore thermal analysis was conducted by changing the  $pO_2$  for the powder obtained by thermal decomposition (or prefiring) of the coating solution. As a result of x-ray diffraction of the product, it became apparent that the production temperature of YBCO could be decreased by 100 °C or more by using low oxygen pressure.<sup>[18]</sup>

In the heat treatment at maximum temperature of around 700 °C, the reaction between the YBCO and a lattice-matched single-crystal substrate such as SrTiO<sub>3</sub> could be sufficiently suppressed, and the YBCO film was formed on the SrTiO<sub>3</sub> substrate. To improve the uniformity and reproducibility of the thickness of the film product, the solution was applied using a spin coater<sup>[19]</sup> and prefiring was done at 500 °C in an ambient atmosphere.

Next we succeeded in decreasing the temperature by about 200 °C from the maximum temperature of the conventional heat process by optimizing the oxygen partial pressure and the heating rate for the final heat treatment of the prefired film (development of the low-temperature process). Figure 6 shows the schematic representation of the stable range of YBCO and copper oxides (Cu<sub>2</sub>O-CuO) on the Ellingham diagram, with the logarithm of oxygen partial pressure ( $pO_2$ ) and the reciprocal of temperature ( $1/T$ ) as the two axes (orientation will be discussed in the next chapter).<sup>[20]</sup> Here, the conventional heat process in oxygen corresponded to Route I-1, while the low-temperature process to Route I-2. Since low-oxygen pressure was used in Route I-2, the non-superconductor YBa<sub>2</sub>Cu<sub>3</sub>O<sub>6</sub> with less oxygen was produced in the final heat treatment, but by switching to 1 atm oxygen after the final heat treatment and allowing the oxygen to be incorporated into the crystal during cooling, it converted to superconductor YBa<sub>2</sub>Cu<sub>3</sub>O<sub>7</sub>. Moreover, as an amazing finding at the time, the YBCO film manufactured in Route I-2 grew epitaxially on the substrate even though it started from the solution, and a  $J_c$  of 1,000,000 A (=1MA) /cm<sup>2</sup>, which is equivalent to that of the YBCO film

made by the gas-phase method was achieved at 77 K. Hence, Goal I-2 was achieved.<sup>[21][22]</sup>

### 5 Deposition of a large-area YBCO film with high $J_c$

In this chapter, setting the “success of epitaxial film formation, achievement of high  $J_c$ ” of Scenario I-2 as core technology, the outline up to the realization of high- $J_c$  large-area film by Scenario II as shown in Fig. 5 is explained.

The YBCO film prepared on SrTiO<sub>3</sub> substrate in chapter 4 was of a small size of 5 mm × 10 mm. Due to the reactivity of the substrate and the film as well as due to lattice mismatch, it was difficult to concurrently achieve the deposition on a large-area sapphire (single-crystal alumina) substrate that was desirable for FCL, as there was strong demand and desire to test the performance of the large-area YBCO film as soon as possible. Therefore, it was decided that, as shown in Scenario II in Fig. 5, while attempting to primarily increase the surface area of the YBCO film on the lattice-matched substrate, II-1, the manufacture of a buffer layer on the sapphire and tuning of YBCO deposition was conducted concurrently, II-2, and the enlargement of superconductor/buffer /sapphire layer was done afterwards, II-3.

#### 5.1 Achievement of large-area deposition on the lattice-matched substrate

For the achievement of Goal II-1, the selection of optimal heating rate in the low-temperature process was the main issue.

When the surface area of the lattice-matched substrate was increased,  $J_c$  tended to decrease compared to the smaller

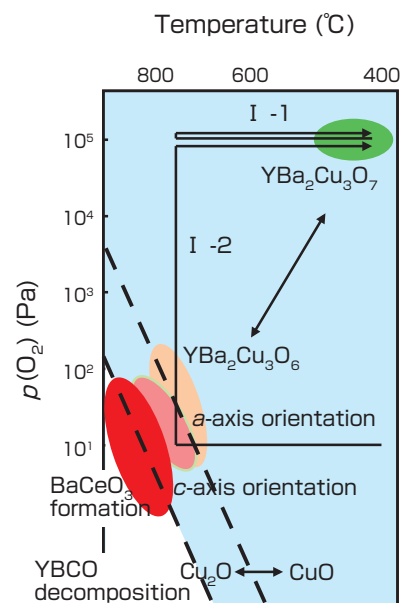

Fig. 6 Orientation and reaction of the YBCO film in the Ellingham diagram



substrate even under the same heat treatment conditions. Initially, we did not know the reason for this, but referring to the Ellingham diagram in Fig. 6, it was revealed that there were areas in which the YBCO films readily become *c*-axis oriented (orientation that the superconducting current easily flows) with high  $J_c$  around the temperature of thermal decomposition of YBCO and CuO, and areas in which the YBCO films readily become *a*-axis oriented (orientation that the superconducting current does not easily flow) with low  $J_c$  in the low-temperature side or areas of high oxygen-partial pressure, just as in the gas phase method.<sup>[23][24]</sup> Using this property, the *c*-axis oriented film is deposited in the *c*-axis oriented area by the gas phase method.<sup>[25]</sup> On the other hand, in the MOD method, since the prefired film that was once deposited underwent final heat treatment, the crystal growth of the *a*-axis grains is likely to occur locally as the substrate surface area increased as it passed through the *a*-axis oriented area in the heat process in the ordinary electrical furnace with a small heating rate. It was thought that the inclusion of the *a*-axis orientation occurred due to this phenomenon.

Therefore we introduced an infrared image furnace that enabled rapid heating. As a result of investigation on the heating rate and uniform heating conditions, the *c*-axis oriented film was obtained by rapid heating, i.e., by quickly passing the low-temperature zone where the *a*-axis orientation tended to occur and the *a*-axis oriented growth was inhibited. The YBCO film with a thickness of 700 nm manufactured on the lattice-matched LaAlO<sub>3</sub> (LAO, mismatch about 2 %) with a diameter of 5 cm was extremely dense and smooth, and  $J_c$  measured by the inductive method was extremely high ( $>2$  MA/cm<sup>2</sup>).<sup>[26][27]</sup> Even with rapid heating, since YBCO and LAO are lattice matched and the thermal expansion coefficients are close (YBCO:  $13 \times 10^{-6}$ /K; LAO:  $12.6 \times 10^{-6}$ /K<sup>[9]</sup>), no cracks occurred. Thus, it was possible to obtain a YBCO thick film with high  $J_c$  on a lattice-matched LAO substrate. However, the maximum size that can be manufactured for a LAO substrate is about 5 cm in diameter, and a larger surface area cannot be obtained. Also, the thermal shock resistance and heat conductivity are low, and the substrate tends to be damaged due to heat stress when it is cooled in liquid nitrogen in the quenching process, and therefore it is considered unsuitable for FCL application.

### 5.2 Formation of a buffer film on a sapphire (lattice-mismatched) substrate

As a substrate material for superconducting films for FCL application, sapphire (single-crystal alumina) is optimal since heat conductivity and thermal shock resistance are high and large-surface area substrate is available. However, sapphire chemically reacts with YBCO, has a different crystal structure, and has large lattice mismatch (about 10 %), and these make the direct epitaxial growth of YBCO difficult. Therefore, similar to the gas phase methods,<sup>[10]-[13]</sup> CeO<sub>2</sub>

(lattice mismatch of about 1 %) was used as the buffer layer to mitigate the lattice mismatch as well as to inhibit chemical reaction.

When the CeO<sub>2</sub> buffer layer was formed by a vacuum vapor deposition method by changing the deposition conditions (temperature, deposition rate, oxygen pressure, and plasma gasification conditions) on the sapphire substrate, the orientation of the CeO<sub>2</sub> could be arranged in desirable directions (100) by plasma gasification of oxygen by a radiofrequency (RF) antenna and by increasing the substrate temperature. Then, the CeO<sub>2</sub> buffer layer with a smooth surface at nanometer level could be obtained.<sup>[28][29]</sup>

Concurrent to the buffer layer deposition, we attempted tuning with the YBCO deposition by the MOD method on the buffer layer. Although the heat treatment condition was about the same as on the lattice-matched substrate, when CeO<sub>2</sub> was used for the buffer layer, the production of BaCeO<sub>3</sub> by reaction with YBCO became an issue. When BaCeO<sub>3</sub> is produced, the amount of Ba in the film decreases, and not only does the metal composition ratio depart from 1:2:3 but also the crystallization property of YBCO decreases and the superconductivity degrades significantly. When we investigated the heat-treatment condition of the YBCO film when the CeO<sub>2</sub> buffer layer was used, it was found that BaCeO<sub>3</sub> was likely to be produced in high temperature or low oxygen partial pressure side, as shown in Fig. 6. It was also found during the optimization of the YBCO deposition condition on the CeO<sub>2</sub> buffer layer, that although CeO<sub>2</sub> had small lattice mismatch with YBCO, it had a fluorite-type crystal structure that was different from YBCO, and the YBCO crystal growth rate became relatively small on CeO<sub>2</sub>. Therefore, no rapid heating using the infrared image furnace was required as in the lattice-matched substrate, and only heating with a tubular furnace was necessary. As a result of tuning the buffer layer deposition method and the heat treatment conditions, we succeeded in depositing YBCO with high  $J_c$  at maximum heat-treatment temperature of about 750 °C, with a CeO<sub>2</sub> buffer layer of 40 nm (achievement of Goal II-2).<sup>[30][31]</sup>

### 5.3 Achievement of large-area superconducting/buffer/sapphire multilayers

Next, we attempted to deposit the buffer layer on a large-area sapphire substrate and to form the superconducting multilayer on this layer. Here, the key issue was the uniformity of thickness of both layers deposited and of temperature and atmosphere of heat treatment.

For the buffer layer deposition, two vapor deposition sources were installed to improve uniformity, the decrease of substrate temperature was prevented by devising a heater and shield, and oxygen was plasma activated by a RF antenna. By increasing the power of RF and maintaining the substrate

temperature high, we obtained a CeO<sub>2</sub> film with a large surface that was smooth and uniform at nanometer level.<sup>[28][29]</sup>

We introduced a spin coater to handle large substrates for the large-area YBCO deposition, and a coating solution that was tuned for viscosity and evaporation rate to ensure even film thickness was applied. Next, in the prefiring process, totally uniform prefired film was obtained using a large muffle or tubular furnace in which the heating rate and the atmosphere were controlled. From the result of subchapter 5.2, it became apparent that rapid heating using the infrared image furnace was not necessary for the final heat treatment, and we succeeded in manufacturing a high-performance YBCO film on a large-area sapphire substrate of 10 cm × 30 cm size, by conducting precise temperature and atmosphere control using a large tubular furnace with high temperature uniformity (Fig. 7). It was on average  $J_c = 2.6 \text{ MA/cm}^2$  as obtained in the inductive method, and the uniformity of average  $J_c$  within ±20 % range was obtained for the majority of the measurement points. The goal value of the project in chapter 2 was achieved (II-3).<sup>[31]-[33]</sup>

## 6 Later development

Up to the previous chapter, we described the development of the synthesis technology of the large-area superconducting film by the MOD method. In this chapter, we shall discuss the later development: (1) the result of manufacturing the fault current limiting element using the superconducting film developed in this research, in a joint research with external institutions (companies, universities, and the Central Research Institute of Electric Power Industry) and a research group within AIST (jointly with Energy Technology Research Institute), and then creating a prototype FCL by a series-parallel arrangement and conducting the current limiting test; and (2) the application to microwave devices and wire rods. Please refer to the references for details.

### 6.1 Prototype FCL test

The superconducting films for the element were prepared by depositing on the CeO<sub>2</sub>/sapphire substrate of 3 cm × 21 cm

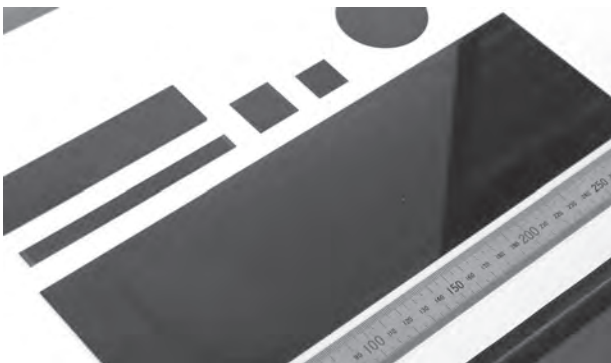

Fig. 7 Large-area YBCO films manufactured on substrates of various forms

size with high throughput and uniformity, and a gold-silver alloy shunt layer with high resistance was formed to increase the voltage produced after quenching.<sup>[34]</sup>

(1) Joint research: mockup device (Fig. 8)

The 6.6 kV class single-phase FCL unit, in which six units of two parallel elements were connected in series, was used to limit the peak current of 11.3 kA to 4.5 kA. Based on this result, conceptual design of the 6.6 kV class triple-phase FCL was done.<sup>[35]</sup>

(2) AIST research:

The 500 V/200 A single-phase FCL unit that used the non-inductive shunt resistance developed by AIST was used to limit the peak current of 3.5 kA to 770 A.<sup>[36]</sup>

The cost of the large-area superconducting film used for FCL in the dispersed distributed power supply site was calculated, and it was shown that in the future it will be lower than the target cost of realization.<sup>[37]</sup>

Based on these results, the technological transfer to companies of the large-area superconducting film manufacturing process is being promoted.

### 6.2 Application to microwave devices and wire rods and tapes

(1) Microwave filter for mobile communication base station

Since the high-temperature superconductor has lower surface resistance than metal in the microwave range, call-enabled areas can be expanded and effect of electromagnetic wave can be decreased by increasing the communication quality by incorporating a filter made from a superconducting film into the mobile communication base station system.<sup>[38][39]</sup> Here, the goals (II-4) required for the superconducting film are double-sided deposition on a large-area (5 cm in diameter), low-permittivity substrate, low surface resistance, and patterning. The authors obtained the following results for the application to this field.

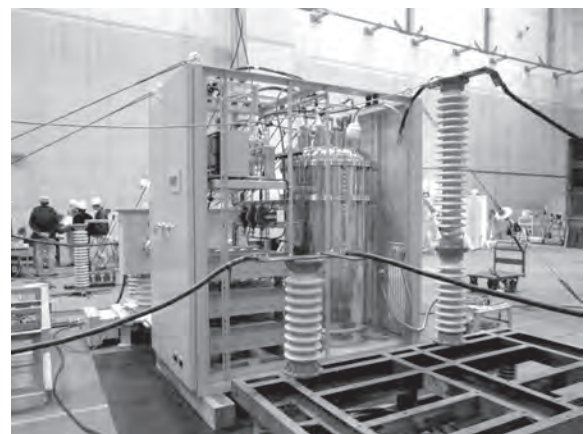

Fig. 8 6.6 kV single-phase FCL prototype

- a. Manufacture of microwave filter on a 2 cm × 2 cm LaAlO<sub>3</sub> substrate and verification of filter performance<sup>[40]</sup>
- b. Achievements of YBCO deposition on a 5 cm diameter LaAlO<sub>3</sub> substrate and low surface resistance<sup>[41]</sup>
- c. Achievements of double-sided YBCO deposition on a 5 cm diameter CeO<sub>2</sub>/sapphire substrate and low surface resistance<sup>[42]</sup>
- d. Possibilities of YBCO deposition by excimer-laser-assisted MOD (ELAMOD) and concurrent patterning<sup>[43]</sup>

## (2) Application to wire rods and tapes

The YBCO superconducting wires and tapes with long length and thickness were achieved by chemical vapor deposition (CVD) and TFA-MOD using trifluoroacetate (TFA) as the raw material. The MOD method discussed in this research is called the fluorine free (FF) MOD method since it does not include harmful fluorine in the raw material, and is expected to become a manufacturing method for superconducting wire rods and tapes at low cost and low environmental load. The authors have been conducting research with the goal of developing high critical current ( $I_c$ ) films (high  $J_c$  and thick film) on oriented metal substrates that can be made long (Goal II-5), and the following results have been obtained to present.

- a. Development of a thick coating solution: 0.8 μm was achieved by a single coat and firing<sup>[44]</sup>
- b. Manufacture of a thick film by repetition of the whole MOD process that includes coating, pre-firing, and final heat treatment: manufactured a 4-μm-thick epitaxial film
- c. Achievement of high  $I_c$  (>200 A/cm) by introducing pinning: highest for a FF-MOD film<sup>[45]</sup>

## 7 Summary

This paper introduced the following two scenarios and elemental technologies that were employed to achieve the goals to meet the product requirements for the technology for a high-quality, large-area superconducting film by the MOD method for the purpose of FCL application.

- I. Verification of YBCO thin film manufacturing and achievement of high  $J_c$
- II. Deposition of a high- $J_c$ , large-area YBCO film

In Scenario I, the main topic was the preparation of a homogeneous coating solution based on solution chemistry and the development of a low-temperature process using low oxygen pressure that is based on solid physical chemistry. Even though we started from the solution, we obtained a high- $J_c$  film that grew epitaxially on the substrate.

On the other hand, in Scenario II, the approach taken was first contemplating the enlargement of the YBCO film on the lattice-matched substrate, II-1, and, concurrently,

conducting the manufacture of the buffer layer on lattice-mismatched sapphire and the tuning of YBCO deposition, II-2. Afterwards, a large surface area was achieved for the superconducting/buffer/sapphire multilayers, II-3. In executing this approach according to the development plan, there were researchers who were specialists of gas phase deposition and those who specialized in liquid phase deposition within the group, and the two sets of researchers collaborated and offered good feedback. It was also crucial that we were able to procure manufacturing and evaluation devices that could handle large substrates at the appropriate time.

These approaches are utilized in the applications to microwave devices and wire rods and tapes.

## Acknowledgements

We are deeply thankful to the Power and System Laboratory of the Furukawa Electric Co., Ltd. that provided us with the photographs of the FCL test. We also thank all the people of the R&D Joint Research Committee of the R&D for Practical Superconducting FCL.

## References

- [1] New Energy and Industrial Technology Development Organization: *R&D of the Core Technology for Superconducting AC Equipment, Fact Sheet*, I-2-I-6 (2005) (in Japanese).  
<http://www.nedo.go.jp/content/100091370.pdf>
- [2] T. Okuma and Y. Iwata: Superconducting fault current limiter, *J. Inst. Elect. Engr. Jpn.*, 117 (4), 222-226 (1997) (in Japanese).
- [3] S. Mizuta, T. Kumagai and T. Manabe: Preparation of superconducting films by dipping-pyrolysis process, *J. Chem. Soc. Jpn.* 1, 11-23 (1997) (in Japanese).
- [4] I. Yamaguchi, T. Manabe, T. Kumagai and S. Mizuta: Preparation of epitaxial oxide films by the coating-pyrolysis process, *J. Magn. Soc. Jpn.*, 24 (8), 1173-1180 (2000) (in Japanese).
- [5] T. Araki, K. Yamagiwa and I. Hirabayashi: Fabrication of YBCO films by metalorganic deposition using trifluoroacetates and its process conditions, *Journal of Cryogenics and Superconductivity Society of Japan*, 35 (11), 516-522 (2000) (in Japanese).
- [6] K. Ueda, K. Yasuda, K. Inoue, A. Kikuchi and K. Iwada: R&D of HTS power cable and fault current limiter in Super-ACE project, *Physica C*, 392-396, 1171-1179 (2003).
- [7] New Energy and Industrial Technology Development Organization: *R&D of the Core Technology for Superconducting AC Equipment, Fact Sheet, Basic Plan I* (2005) (in Japanese).  
<http://www.nedo.go.jp/content/100091370.pdf>
- [8] G. Kästner, D. Hesse, M. Lorenz, R. Scholz, N.D. Zakharov and P. Kopperschmidt: Microcracks observed in epitaxial thin films of YBa<sub>2</sub>Cu<sub>3</sub>O<sub>7-δ</sub> and GdBa<sub>2</sub>Cu<sub>3</sub>O<sub>7-δ</sub>, *Phys. Stat. Sol. (a)*, 150 (1), 381-394 (1995).
- [9] M. Kawasaki: Thin-film technology for high- $T_c$  superconducting devices, *J. Cryo. Soc. Jpn.*, 31 (11), 563-571

- (1996) (in Japanese).
- [10] H. Kinder, P. Berberich, W. Prusseit, S. Rieder-Zecha, R. Semerad and B. Utz: YBCO film deposition on very large areas up to  $20 \times 20 \text{ cm}^2$ , *Physica C*, 282-287 (1), 107-110 (1997).
- [11] C. Hoffmann, A. Lümckemann, U. Schmatz, M. Bauer, R. Metzger, P. Berberich and H. Kinder:  $\text{YBa}_2\text{Cu}_3\text{O}_{7-x}$  deposition of large moving plates for continuous processing, *IEEE Trans. Appl. Supercond.*, 13 (2), 2879-2881 (2003).
- [12] B. Schey, W. Biegel, M. Kuhn and B. Stritzker: Large area pulsed laser deposition of YBCO thin films, *IEEE Trans. Appl. Supercond.*, 9 (2), 2359-2362 (1999).
- [13] J. Geerk, F. Ratzel, H. Rietschel, G. Linker, R. Heidinger and R. Schwab: Simultaneous double-sided deposition of HTS films on 3-inch wafers by ICM-sputtering, *IEEE Trans. Appl. Supercond.*, 9 (2), 1543-1546 (1999).
- [14] T. Kumagai, H. Yokota, K. Kawaguchi, W. Kondo and S. Mizuta: Preparation of superconducting  $\text{YBa}_2\text{Cu}_3\text{O}_{7-\delta}$  (YBCO) thin films by the dipping-pyrolysis process using organic acid salts, *Chem. Lett.*, 1987 (8), 1645-1646 (1987).
- [15] T. Manabe, H. Yokota, T. Kumagai, W. Kondo and S. Mizuta: Preparation of superconducting  $\text{Ba}_2\text{YCu}_3\text{O}_{7-\delta}$  films by the dipping-pyrolysis process using metal laurates, *JCS-Japan*, 98 (2), 220-224 (1990) (in Japanese).
- [16] T. Kumagai, W. Kondo, H. Yokota, H. Minamiue and S. Mizuta: Preparation of superconducting  $\text{YBa}_2\text{Cu}_3\text{O}_{7-\delta}$  films by the dipping-pyrolysis process using metal acetylacetonates, *Chem. Lett.*, 1988 (3), 551-552 (1988).
- [17] K. Kishio, J. Shimoyama, T. Hasegawa, K. Kitazawa and K. Fueki: Determination of oxygen nonstoichiometry in a high- $T_c$  superconductor  $\text{Ba}_2\text{YCu}_3\text{O}_{7-\delta}$ , *Jpn. J. Appl. Phys.*, 26 (7), L1228-L1230 (1987).
- [18] T. Kumagai, T. Manabe, W. Kondo, H. Minamiue and S. Mizuta: Effects of heat treatment conditions on the critical current densities of  $\text{Ba}_2\text{YCu}_3\text{O}_{7-y}$  films prepared by the dipping-pyrolysis process, *Jpn. J. Appl. Phys.*, 29, L940-L942 (1990).
- [19] T. Manabe, W. Kondo, S. Mizuta and T. Kumagai: Preparation of high- $J_c$   $\text{Ba}_2\text{YCu}_3\text{O}_{7-y}$  films on  $\text{SrTiO}_3(100)$  substrates by the dipping-pyrolysis process at  $750^\circ\text{C}$ , *Jpn. J. Appl. Phys.*, 30 (9B), L1641-L1643 (1991).
- [20] T. Manabe, K. Arai, W. Kondo, S. Mizuta and T. Kumagai: Preparation of  $\text{YBa}_2\text{Cu}_3\text{O}_{7-y}$  films on  $\text{SrTiO}_3$  and  $\text{MgO}$  by the dipping-pyrolysis process under low- $p(\text{O}_2)$  heat treatment, *J. Mater. Res.*, 7 (9), 2337-2342 (1992).
- [21] T. Kumagai, T. Manabe, W. Kondo, S. Mizuta and K. Arai: Preparation of high  $J_c$   $\text{Ba}_2\text{YCu}_3\text{O}_{7-y}$ -Ag composite films on  $\text{SrTiO}_3(100)$  substrates by the dipping-pyrolysis process, *Appl. Phys. Lett.*, 61 (8), 988-990 (1992).
- [22] T. Kumagai, H. Yamasaki, K. Endo, T. Manabe, H. Niino, T. Tsunoda, W. Kondo and S. Mizuta: Critical current densities at 77K in  $\text{Ba}_2\text{YCu}_3\text{O}_{7-y}$ -Ag films prepared by dipping-pyrolysis process, *Jpn. J. Appl. Phys.*, 32 (11A), L1602-L1605 (1993).
- [23] T. Manabe, W. Kondo, S. Mizuta and T. Kumagai: Crystallization of  $\text{YBa}_2\text{Cu}_3\text{O}_{7-y}$  films on  $\text{SrTiO}_3(100)$  by postannealing of precursors prepared by dipping-pyrolysis process, *J. Mater. Res.*, 9 (4), 858-865 (1994).
- [24] T. Manabe, I. Yamaguchi, W. Kondo, S. Mizuta and T. Kumagai: Processing of superconducting films and tapes by dipping-pyrolysis process, in K. Yamafuji and T. Morishita (eds.), *Advances in Superconductivity VII /2*, Springer, 589-594 (1994).
- [25] M. Mukaida and S. Miyazawa: Nature of preferred orientation of  $\text{YBa}_2\text{Cu}_3\text{O}_x$  thin films, *Jpn. J. Appl. Phys.*, 32, 4521-4528 (1993).
- [26] T. Manabe, W. Kondo, I. Yamaguchi, M. Sohma, T. Tsuchiya, K. Tsukada, S. Mizuta and T. Kumagai: Critical current density and microwave surface resistance of 5-cm-diameter YBCO films on  $\text{LaAlO}_3$  substrates prepared by MOD using an infrared image furnace, *Physica C*, 417, 98-102 (2005).
- [27] T. Manabe, M. Sohma, I. Yamaguchi, K. Tsukada, W. Kondo, K. Kamiya, T. Tsuchiya, S. Mizuta and T. Kumagai: Surface resistances of 5-cm-diameter YBCO films prepared by MOD for microwave applications, *Physica C*, 445-448, 823-827 (2006).
- [28] M. Sohma, I. Yamaguchi, K. Tsukada, W. Kondo, S. Mizuta, T. Manabe and T. Kumagai: Cerium oxide ( $\text{CeO}_2$ ) buffer layers for preparation of high- $J_c$  YBCO films on large-area sapphire substrates ( $30 \text{ cm} \times 10 \text{ cm}$ ) by coating pyrolysis, *Physica C*, 412-414, 1326-1330 (2004).
- [29] M. Sohma, I. Yamaguchi, K. Tsukada, W. Kondo, K. Kamiya, S. Mizuta, T. Manabe and T. Kumagai: Preparation of  $\text{CeO}_2$  buffer layers for large-area MOD-YBCO films ( $10 \times 30 \text{ cm}^2$ ) with high- $J_c$ , *IEEE Trans. Appl. Supercond.*, 15 (2), 2699-2702 (2005).
- [30] T. Manabe, M. Sohma, I. Yamaguchi, W. Kondo, K. Tsukada, S. Mizuta and T. Kumagai: 2-D large-size YBCO films on sapphire for FCL prepared by coating-pyrolysis process, *Physica C*, 392-396, 937-940 (2003).
- [31] T. Manabe, M. Sohma, I. Yamaguchi, W. Kondo, K. Tsukada, K. Kamiya, S. Mizuta and T. Kumagai: Distribution of inductive  $J_c$  in two-dimensional large-size YBCO films prepared by fluorine-free MOD on  $\text{CeO}_2$ -buffered sapphire, *IEEE Trans. Appl. Supercond.*, 15 (2), 2923-2926 (2005).
- [32] T. Manabe, M. Sohma, I. Yamaguchi, W. Kondo, K. Tsukada, S. Mizuta and T. Kumagai: Preparation of high- $J_c$  large-size YBCO films ( $30 \times 10 \text{ cm}^2$ ) by coating-pyrolysis process on  $\text{CeO}_2$ -buffered sapphire, *Physica C*, 412-414, 896-899 (2004).
- [33] K. Osamura and K. Matsumoto: Development of practical high-temperature superconducting conductors and their future trends, *Oyo Buturi*, 73 (1), 3-13 (2004) (in Japanese).
- [34] H. Yamasaki, M. Furuse and Y. Nakagawa: High-power-density fault-current limiting devices using superconducting  $\text{YBa}_2\text{Cu}_3\text{O}_7$  films and high-resistivity alloy shunt layers, *Appl. Phys. Lett.*, 85, 4427-4429 (2004).
- [35] T. Nitta, T. Matsumura, J. Baba, M. D. Ainslie, S. Torii, H. Kado, T. Kumagai and M. Shibuya: Tests for conceptual design of 6.6 kV class superconducting fault current limiter with YBCO thin film elements, *IEEE Trans. Appl. Supercond.*, 19 (3), 1964-1967 (2009).
- [36] H. Yamasaki, K. Arai, K. Kaiho, Y. Nakagawa, M. Sohma, W. Kondo, I. Yamaguchi, H. Matsui, T. Kumagai, N. Natori and N. Higuchi: 500 V/200 A fault current limiter modules made of large-area MOD- $\text{YBa}_2\text{Cu}_3\text{O}_7$  thin films with high-resistivity Au-Ag alloy shunt layers, *Supercond. Sci. Tech.*, 22 (12), 125007 (2009).
- [37] H. Yamasaki, K. Arai, M. Furuse, Y. Nakagawa, K. Kaiho, T. Kumagai, M. Shibuya and T. Nitta: Comparison of estimated conductor costs between a superconducting thin-film fault-current limiter (FCL) and a coated-conductor-based superconducting FCL, *J. Cryo. Jpn.*, 41 (9), 397-404 (2006) (in Japanese).
- [38] K. Setsune and A. Enokihara: Application of high- $T_c$  superconductors for mobile telecommunication systems: Microwave filters for base stations, *Oyo Buturi*, 66 (4), 351-355 (1997) (in Japanese).

- [39] N. Sakakibara: Compact high-temperature superconductor filter, *Oyo Buturi*, 72 (1), 21-26 (2003) (in Japanese).
- [40] T. Kumagai, T. Manabe, I. Yamaguchi, S. Nakamura, W. Kondo, S. Mizuta, F. Imai, K. Murayama, A. Shimokobe and Y-M. Kang: Preparation of YBCO films by CP-process for HTS microwave filters, in T. Yamashita and K. Tanabe (eds.), *Advances in Superconductivity XII*, Springer, 927-929 (2000).
- [41] T. Kumagai, T. Manabe, W. Kondo, K. Murayama, T. Hashimoto, Y. Kobayashi, I. Yamaguchi, M. Sohma, T. Tsuchiya, K. Tsukada and S. Mizuta: Characterization of 50-mm-diameter Y123 films prepared by a coating-pyrolysis process using an infrared image furnace, *Physica C*, 378-381, 1236-1240 (2002).
- [42] M. Sohma, K. Kamiya, K. Tsukada, I. Yamaguchi, W. Kondo, S. Mizuta, T. Manabe and T. Kumagai: Fabrication of double-sided YBa<sub>2</sub>Cu<sub>3</sub>O<sub>7</sub> films on CeO<sub>2</sub>-buffered sapphire substrates by MOD process, *IEICE Trans. Electron.*, E89-C (2), 182-185 (2006).
- [43] M. Sohma, T. Tsuchiya, K. Tsukada, I. Yamaguchi, T. Manabe, T. Kumagai, K. Koyanagi, T. Ebisawa and H. Ohtsu: Preparation of epitaxial YBCO films by a novel excimer-laser-assisted MOD, *IEEE Trans. Appl. Supercond.*, 17 (2), 3612-3615 (2007).
- [44] I. Yamaguchi, W. Kondo, T. Hikata, K. Kamiya, H. Matsui, M. Sohma, K. Tsukada, Y. Nakagawa, T. Kumagai and T. Manabe: Preparation of Y123 thick films by fluorine-free MOD using a novel solution, *IEEE Trans. Appl. Supercond.*, 21 (3), 2775 -2778 (2011).
- [45] H. Matsui, H. Ogiso, H. Yamasaki, T. Kumagai, M. Sohma, I. Yamaguchi and T. Manabe: 4-fold enhancement in the critical current density of YBa<sub>2</sub>Cu<sub>3</sub>O<sub>7</sub> films by practical ion irradiation, *Appl. Phys. Lett.*, 101 (23), 232601 (2012).

Leader, Thin Films Processing Research Group, Advanced Manufacturing Research Institute, AIST in 2014. In this paper, engaged in the synthesis of high-quality buffer layer suitable for superconducting film and the application of high-performance thin film to superconducting film by the coating irradiation method.

#### Iwao YAMAGUCHI

Completed the master's course at the Graduate School of Engineering, Kyoto University in 1994. Joined the National Chemical Laboratory for Industry, Agency of Industrial Science and Technology in 1994. Worked at the Inorganic Materials Section at NCL; Institute for Materials and Chemical Process, AIST; and currently, Senior Researcher, Advanced Manufacturing Research Institute, AIST. Obtained the doctorate (Engineering) at the Graduate School of Engineering, Kyoto University in 2009. In this paper, engaged in the synthesis and evaluation of the epitaxial thin film of superconductors and various oxides, as well as the thick film manufacturing process and its application to superconducting tape.



#### Hiroaki MATSUI

Completed the doctorate at the Graduate School of Science, Tohoku University in 2006. After Assistant Professorship at the Tohoku University, joined AIST in 2008. Currently, Senior Researcher, Advanced Manufacturing Research Institute, AIST. Doctor (Science). In this paper, engaged in the synthesis of high-performance superconducting film by coating irradiation method, and the clarification of mechanism for generating high-density critical current by nanostructure control.



#### Tetsuo TSUCHIYA

Completed the doctorate at the Graduate School of Science and Technology, Tokyo University of Science in 1998. After COE Fellowship at the National Institute of Materials and Chemical Research, Agency of Industrial Science and Technology, joined AIST in 2000; and Leader, Flexible Chemical Research Group, Advanced Manufacturing Research Institute, AIST in 2010. Doctor of Engineering. Got the idea for crystal growth for functional thin films by laser-assisted MOD in 1999. Since then, developed the flexible thin film methods by low-temperature multicrystal growth of metal oxides by photodecomposition of metal organic compounds, epitaxial growth, and nano-particle photoreaction. In this paper, engaged in the development of manufacturing process of superconductor by coating irradiation method.



#### Toshiya Kumagai

Graduated from the Department of Applied Chemistry, School of Science and Engineering, Waseda University in 1974. Joined the National Chemical Laboratory for Industry, Agency of Industrial Science and Technology in 1975; Group Leader, AIST in 2001; Deputy Director, Advanced Manufacturing Research Institute, AIST in 2009; and currently, Invited Senior Researcher. Doctor (Engineering). Winner of Contribution



## Authors

### Takaaki MANABE

Graduated from the Department of Synthetic Chemistry, School of Engineering, The University of Tokyo in 1988. Joined the National Chemical Laboratory for Industry, Agency of Industrial Science and Technology in 1988. Leader, Thin Films Processing Research Group, Advanced Manufacturing Research Institute, AIST in 2009. Chief Planning Officer, Compliance Headquarter, AIST (also worked at the Advanced Manufacturing Research Institute) in 2014. Winner of Contribution Award of the Ichimura Prize in Technology, Progress Award of the Ceramic Society of Japan, and others. Engages in the synthesis of world-class large-area superconducting film and its application to FCL. In this paper, was mainly in charge of Scenario II.



### Mitsugu SOHMA

Completed the master's course at the Department of Applied Chemistry, Graduate School of Engineering, Hokkaido University in 1989. Joined the National Chemical Laboratory for Industry, Agency of Industrial Science and Technology in 1989. Obtained the doctorate degree (Engineering) for research in magnetic thin film in 1996. Senior Researcher, Institute for Materials and Chemical Process, AIST in 2001.



Award of the Ichimura Prize in Technology and others. Engaged in the inorganic materials science research mainly for energy related applications. Succeeded for the first time in the world to synthesize the YBCO superconducting film using this method in 1987, and led the R&D for its synthesis and application. In this paper, was mainly in charge of Scenario I.

## Discussions with Reviewers

### 1 Overall

**Comment (Hiroshi Akoh, Thermal Management Materials and Technology Research Association)**

This paper focuses on the target of electrical application of a high-temperature oxide superconductor to the fault current limiter, and builds the scenario for its development and shows the selection and combination of the elemental technologies. I think it is valuable as a *Synthesiology* paper.

**Comment (Tetsuhiko Kobayashi, AIST)**

This paper is about the creation of a large-area superconducting film for application to FCL, and I recommend its publication in the journal.

### 2 Explanation of FCL

**Question and Comment (Hiroshi Akoh)**

In this paper, the development of FCL is given as the electric power application of high-temperature oxide superconductors. Therefore, I think it is important to show a diagram that allows the readers outside the field to grasp the image of FCL. In the paper, the structure and operational principle of FCL are shown in diagrams, and it is described in the text in chapter 2, however I think readers can more easily understand if you present a figure that shows the role and importance of FCL in the power grid system. Also, I think you can clarify the correspondence to the photograph of the device which includes the prototype FCL shown in Fig. 8.

Moreover, there is a description of “development of many types of FCLs” in chapter 1, however I think you should clarify by giving specific examples of other types of FCLs.

**Answer (Toshiya Kumagai)**

I added a figure that shows the role of FCL in the power grid system as Fig. 1, and inserted in the upper part of Fig. 2 a figure that shows the “FCL cooled in the cryostat” that shows correspondence to the photo of the device in Fig. 8.

I added a few examples of active and passive FCLs in chapter 2.

### 3 Relationship of Scenarios I and II

**Question and Comment (Hiroshi Akoh)**

I understand that Scenarios I and II are continuously related toward the development of FCL, however the relationship of Scenarios I and II seems to become unclear since you explain them separately in Figs. 4 and 5. I think the main point of this paper is that you succeeded in achieving high  $T_c$  and high  $J_c$  by the MOD method, and using that as core technology and advancing the R&D to achieve a large-area film and multilayer, there was considerable progress in the FCL development. I think the scenario continues to mention that the application can extend to microwave devices by achieving low surface resistance and patterning, and in the future it can be applied to superconducting wires by achieving the long length and thick thickness. What do you think of the scenario where you discuss mainly the development of FCL and then spreading out to microwave devices and superconducting wire applications?

**Answer (Toshiya Kumagai and Takaaki Manabe)**

The scenario of the whole paper and its main point are as you indicated. However, describing the research in chronological order, it was still unclear that FCL was the outlet when we

were setting Scenario I (at the time of discovery of the high-temperature superconductor). The application to various electric power devices was a “dream,” and in reality, we conducted R&D for “high  $J_c$ ” as the essential goal to realize that dream. Later, when we achieved high  $J_c$ , we could regard various devices including FCL as specific targets, and only then did we set the goal to fulfill the product requirements, build the scenario to achieve them, and then engaged in the R&D. In this paper, we focus on the application to FCL, but we have concurrently worked on the application to microwave devices to some extent. Considering these points, we shall describe Scenarios I and II separately in the figures. In Fig. 5, we specify that the “success of epitaxial deposition and achievement of high  $J_c$ ” in I-2 are the core technologies in Scenario II.

### 4 Characteristic of the MOD method

**Question and Comment (Tetsuhiko Kobayashi)**

You describe in subchapter 1.2 as one of the characteristics of MOD that “(4) it has low environmental load since it emits only steam and carbon dioxide during firing,” but aren’t VOC and incomplete combustion gas produced depending on the condition?

**Answer (Takaaki Manabe)**

As you indicated gases such as VOC may be produced in incomplete combustion. Also, this item is not a characteristic of the MOD method compared with the gas phase method, but is the characteristic of the FF-MOD method using fluorine-free materials that was employed in this paper, in contrast to the TFA-MOD method that uses trifluoroacetate as the raw material. I added and revised item 4 to make this clear to the readers.

### 5 Infrared rapid heating process

**Question and Comment (Hiroshi Akoh)**

This is a technical question. As you describe in chapter 5, you developed the rapid heating process by infrared heating to inhibit the  $a$ -axis oriented growth and to obtain the  $c$ -axis oriented film. Were there any cracks in the film due to the difference in thermal expansion coefficients of the substrate and the film? Please explain if there were no cracks.

**Answer (Takaaki Manabe)**

No cracks occurred by rapid heating for the YBCO film with thickness of 700 nm on LAO. I explained that it is because they are lattice matched and their thermal expansion coefficients are close.

Also, the film on sapphire that has large thermal expansion difference tends to get micro-cracks during cooling after deposition, and the thickness of the YBCO film is limited to 300 nm or less. I added this in chapter 2.

### 6 Achievement of a large-area thin films and a low-temperature process

**Question and Comment (Tetsuhiko Kobayashi)**

To achieve a large-area thin films, you say, “a low-temperature process was developed to increase the  $J_c$  by decreasing the interface reaction between the film and the substrate and by improving the orientation.” For readers outside the field, the meaning of “decreasing the interface reaction between the film and the substrate” is difficult to understand, and I think you need some supplementary explanation.

**Answer (Takaaki Manabe)**

Including the point that you indicated, the description of the draft was not well organized, so I changed the description to the following: the chemical reaction occurs at the interface between the YBCO film and the substrate when the firing temperature is high → a low-temperature process was developed to inhibit the interface reaction → this low temperature allowed use of lattice-matched substrates → orientation of the YBCO film was improved using the lattice-matched substrate.

## MESSAGES FROM THE EDITORIAL BOARD

There has been a wide gap between science and society. The last three hundred years of the history of modern science indicates to us that many research results disappeared or took a long time to become useful to society. Due to the difficulties of bridging this gap, this stage has been recently called the valley of death or the nightmare stage<sup>(Note 1)</sup>. Rather than passively waiting, therefore, researchers and engineers who understand the potential of the research should actively try to bridge the gap.

To bridge the gap, technology integration<sup>(i.e. Type 2 Basic Research – Note 2)</sup> of scientific findings for utilizing them in society, in addition to analytical research, has been one of the wheels of progress<sup>(i.e. Full Research – Note 3)</sup>. Traditional journals, have been collecting much analytical type knowledge that is factual knowledge and establishing many scientific disciplines<sup>(i.e. Type 1 Basic Research – Note 4)</sup>. Technology integration research activities, on the other hand, have been kept as personal know-how. They have not been formalized as universal knowledge of what ought to be done.

As there must be common theories, principles, and practices in the methodologies of technology integration, we regard it as basic research. This is the reason why we have decided to publish “*Synthesiology*”, a new academic journal. *Synthesiology* is a coined word combining “synthesis” and “ology”. Synthesis which has its origin in Greek means integration. Ology is a suffix attached to scientific disciplines.

Each paper in this journal will present scenarios selected for their societal value, identify elemental knowledge and/or technologies to be integrated, and describe the procedures and processes to achieve this goal. Through the publishing of papers in this journal, researchers and engineers can enhance the transformation of scientific outputs into the societal prosperity and make technical contributions to sustainable development. Efforts such as this will serve to increase the significance of research activities to society.

We look forward to your active contributions of papers on technology integration to the journal.

*Addendum to Synthesiology-English edition,*

*“Synthesiology-English edition” is a translated version of “Synthesiology”, which is published quarterly, ISSN 1882-6229, by AIST.*

*Papers or articles published in “Synthesiology-English edition” appear approximately four months after the publication of the original “Synthesiology”. Those published in Japanese are translated into English, so the views expressed in translated versions are exclusively those of the Japanese authors and editors. The Japanese authors are generally consulted regarding the translation of their papers, but are not responsible for the published English version.*

*Papers or articles in the “Synthesiology” originally submitted in English are also reproduced just as they were published in “Synthesiology”. Some papers or articles in “Synthesiology” are not translated due to the authors’ or editors’ judgement.*

*Synthesiology Editorial Board*  
(written in January, 2008)

**Note 1 :** The period was named “nightmare stage” by Hiroyuki Yoshikawa, the then President of AIST, and historical scientist Joseph Hatvany. The “valley of death” was used by Vernon Ehlers in 1998 when he was Vice Chairman of US Congress, Science and Technology Committee. Lewis Branscomb, Professor emeritus of Harvard University, called this gap as “Darwinian sea” where natural selection takes place.

**Note 2 :** *Type 2 Basic Research*

This is a research type where various known and new knowledge is combined and integrated in order to achieve the specific goal that has social value. It also includes research activities that develop common theories or principles in technology integration.

**Note 3 :** *Full Research*

This is a research type where the theme is placed within the scenario toward the future society, and where framework is developed in which researchers from wide range of research fields can participate in studying actual issues. This research is done continuously and concurrently from *Type 1 Basic Research*<sup>(Note 4)</sup> to *Product Realization Research*<sup>(Note 5)</sup>, centered by *Type 2 Basic Research*<sup>(Note 2)</sup>.

**Note 4 :** *Type 1 Basic Research*

This is an analytical research type where unknown phenomena are analyzed, by observation, experimentation, and theoretical calculation, to establish universal principles and theories.

**Note 5 :** *Product Realization Research*

This is a research where the results and knowledge from *Type 1 Basic Research* and *Type 2 Basic Research* are applied to embody use of a new technology in the society.

# Editorial Policy

*Synthesiology* Editorial Board

## Objective of the journal

The objective of *Synthesiology* is to publish papers that address the integration of scientific knowledge or how to combine individual elemental technologies and scientific findings to enable the utilization in society of research and development efforts. The authors of the papers are researchers and engineers, and the papers are documents that describe, using “scientific words”, the process and the product of research which tries to introduce the results of research to society. In conventional academic journals, papers describe scientific findings and technological results as facts (i.e. factual knowledge), but in *Synthesiology*, papers are the description of “the knowledge of what ought to be done” to make use of the findings and results for society. Our aim is to establish methodology for utilizing scientific research result and to seek general principles for this activity by accumulating this knowledge in a journal form. Also, we hope that the readers of *Synthesiology* will obtain ways and directions to transfer their research results to society.

## Content of paper

The content of the research paper should be the description of the result and the process of research and development aimed to be delivered to society. The paper should state the goal of research, and what values the goal will create for society (Items 1 and 2, described in the Table). Then, the process (the scenario) of how to select the elemental technologies, necessary to achieve the goal, how to integrate them, should be described. There should also be a description of what new elemental technologies are required to solve a certain social issue, and how these technologies are selected and integrated (Item 3). We expect that the contents will reveal specific knowledge only available to researchers actually involved in the research. That is, rather than describing the combination of elemental technologies as consequences, the description should include the reasons why the elemental technologies are selected, and the reasons why new methods are introduced (Item 4). For example, the reasons may be: because the manufacturing method in the laboratory was insufficient for industrial application; applicability was not broad enough to stimulate sufficient user demand rather than improved accuracy; or because there are limits due to current regulations. The academic details of the individual elemental technology should be provided by citing published papers, and only the important points can be described. There should be description of how these elemental technologies

are related to each other, what are the problems that must be resolved in the integration process, and how they are solved (Item 5). Finally, there should be descriptions of how closely the goals are achieved by the products and the results obtained in research and development, and what subjects are left to be accomplished in the future (Item 6).

## Subject of research and development

Since the journal aims to seek methodology for utilizing the products of research and development, there are no limitations on the field of research and development. Rather, the aim is to discover general principles regardless of field, by gathering papers on wide-ranging fields of science and technology. Therefore, it is necessary for authors to offer description that can be understood by researchers who are not specialists, but the content should be of sufficient quality that is acceptable to fellow researchers.

Research and development are not limited to those areas for which the products have already been introduced into society, but research and development conducted for the purpose of future delivery to society should also be included.

For innovations that have been introduced to society, commercial success is not a requirement. Notwithstanding there should be descriptions of the process of how the technologies are integrated taking into account the introduction to society, rather than describing merely the practical realization process.

## Peer review

There shall be a peer review process for *Synthesiology*, as in other conventional academic journals. However, peer review process of *Synthesiology* is different from other journals. While conventional academic journals emphasize evidential matters such as correctness of proof or the reproducibility of results, this journal emphasizes the rationality of integration of elemental technologies, the clarity of criteria for selecting elemental technologies, and overall efficacy and adequacy (peer review criteria is described in the Table).

In general, the quality of papers published in academic journals is determined by a peer review process. The peer review of this journal evaluates whether the process and rationale necessary for introducing the product of research and development to society are described sufficiently well.



In other words, the role of the peer reviewers is to see whether the facts necessary to be known to understand the process of introducing the research finding to society are written out; peer reviewers will judge the adequacy of the description of what readers want to know as reader representatives.

In ordinary academic journals, peer reviewers are anonymous for reasons of fairness and the process is kept secret. That is because fairness is considered important in maintaining the quality in established academic journals that describe factual knowledge. On the other hand, the format, content, manner of text, and criteria have not been established for papers that describe the knowledge of “what ought to be done.” Therefore, the peer review process for this journal will not be kept secret but will be open. Important discussions pertaining to the content of a paper, may arise in the process of exchanges with the peer reviewers and they will also be published. Moreover, the vision or desires of the author that cannot be included in the main text will be presented in the exchanges. The quality of the journal will be guaranteed by making the peer review process transparent and by disclosing the review process that leads to publication.

Disclosure of the peer review process is expected to indicate what points authors should focus upon when they contribute to this journal. The names of peer reviewers will be published since the papers are completed by the joint effort of the authors and reviewers in the establishment of the new paper format for *Synthesiology*.

## References

As mentioned before, the description of individual elemental technology should be presented as citation of papers published in other academic journals. Also, for elemental technologies that are comprehensively combined, papers that describe advantages and disadvantages of each elemental technology can be used as references. After many papers are accumulated through this journal, authors are recommended to cite papers published in this journal that present similar procedure about the selection of elemental technologies and the introduction to society. This will contribute in establishing a general principle of methodology.

## Types of articles published

*Synthesiology* should be composed of general overviews such as opening statements, research papers, and editorials. The Editorial Board, in principle, should commission overviews. Research papers are description of content and the process of research and development conducted by the researchers themselves, and will be published after the peer review process is complete. Editorials are expository articles for science and technology that aim to increase utilization by society, and can be any content that will be useful to readers of *Synthesiology*. Overviews and editorials will be examined by the Editorial Board as to whether their content is suitable for the journal. Entries of research papers and editorials are accepted from Japan and overseas. Manuscripts may be written in Japanese or English.

## Required items and peer review criteria (January 2008)

	Item	Requirement	Peer Review Criteria
1	Research goal	Describe research goal (“product” or researcher’s vision).	Research goal is described clearly.
2	Relationship of research goal and the society	Describe relationship of research goal and the society, or its value for the society.	Relationship of research goal and the society is rationally described.
3	Scenario	Describe the scenario or hypothesis to achieve research goal with “scientific words”.	Scenario or hypothesis is rationally described.
4	Selection of elemental technology(ies)	Describe the elemental technology(ies) selected to achieve the research goal. Also describe why the particular elemental technology(ies) was/were selected.	Elemental technology(ies) is/are clearly described. Reason for selecting the elemental technology(ies) is rationally described.
5	Relationship and integration of elemental technologies	Describe how the selected elemental technologies are related to each other, and how the research goal was achieved by composing and integrating the elements, with “scientific words”.	Mutual relationship and integration of elemental technologies are rationally described with “scientific words”.
6	Evaluation of result and future development	Provide self-evaluation on the degree of achievement of research goal. Indicate future research development based on the presented research.	Degree of achievement of research goal and future research direction are objectively and rationally described.
7	Originality	Do not describe the same content published previously in other research papers.	There is no description of the same content published in other research papers.

# Instructions for Authors

“*Synthesiology*” Editorial Board

Established December 26, 2007

Revised June 18, 2008

Revised October 24, 2008

Revised March 23, 2009

Revised August 5, 2010

Revised February 16, 2012

Revised April 17, 2013

Revised May 9, 2014

## 1 Types of articles submitted and their explanations

The articles of *Synthesiology* include the following types:

- Research papers, commentaries, roundtable talks, and readers’ forums

Of these, the submitted manuscripts of research papers and commentaries undergo review processes before publication. The roundtable talks are organized, prepared, and published by the Editorial Board. The readers’ forums carry writings submitted by the readers, and the articles are published after the Editorial Board reviews and approves. All articles must be written so they can be readily understood by the readers from diverse research fields and technological backgrounds. The explanations of the article types are as follows.

### ① Research papers

A research paper rationally describes the concept and the design of R&D (this is called the scenario), whose objective is to utilize the research results in society, as well as the processes and the research results, based on the author’s experiences and analyses of the R&D that was actually conducted. Although the paper requires the author’s originality for its scenario and the selection and integration of elemental technologies, whether the research result has been (or is being) already implemented in society at that time is not a requirement for the submission. The submitted manuscript is reviewed by several reviewers, and the author completes the final draft based on the discussions with the reviewers. Views may be exchanged between the reviewers and authors through direct contact (including telephone conversations, e-mails, and others), if the Editorial Board considers such exchange necessary.

### ② Commentaries

Commentaries describe the thoughts, statements, or trends and analyses on how to utilize or spread the results of R&D to society. Although the originality of the statements is not required, the commentaries should not be the same or similar to any articles published in the past. The submitted manuscripts will be reviewed by the Editorial Board. The authors will be contacted if corrections or revisions are necessary, and the authors complete the final draft based on the Board members’ comments.

### ③ Roundtable talks

Roundtable talks are articles of the discussions or interviews

that are organized by the Editorial Board. The manuscripts are written from the transcripts of statements and discussions of the roundtable participants. Supplementary comments may be added after the roundtable talks, if necessary.

### ④ Readers’ forums

The readers’ forums include the readers’ comments or thoughts on the articles published in *Synthesiology*, or articles containing information useful to the readers in line with the intent of the journal. The forum articles may be in free format, with 1,200 Japanese characters or less. The Editorial Board will decide whether the articles will be published.

## 2 Qualification of contributors

There are no limitations regarding author affiliation or discipline as long as the content of the submitted article meets the editorial policy of *Synthesiology*, except authorship should be clearly stated. (It should be clearly stated that all authors have made essential contributions to the paper.)

## 3 Manuscripts

### 3.1 General

3.1.1 Articles may be submitted in Japanese or English.

Accepted articles will be published in *Synthesiology* (ISSN 1882-6229) in the language they were submitted. All articles will also be published in *Synthesiology - English edition* (ISSN 1883-0978). The English edition will be distributed throughout the world approximately four months after the original *Synthesiology* issue is published. Articles written in English will be published in English in both the original *Synthesiology* as well as the English edition. Authors who write articles for *Synthesiology* in Japanese will be asked to provide English translations for the English edition of the journal within 2 months after the original edition is published.

3.1.2 Research papers should comply with the structure and format stated below, and editorials should also comply with the same structure and format except subtitles and abstracts are unnecessary.

3.1.3 Research papers should only be original papers (new literary work).

3.1.4 Research papers should comply with various guidelines of

research ethics

### 3.2 Structure

3.2.1 The manuscript should include a title (including subtitle), abstract, the name(s) of author(s), institution/contact, main text, and keywords (about 5 words).

3.2.2 Title, abstract, name of author(s), keywords, and institution/contact shall be provided in Japanese and English.

3.2.3 The manuscript shall be prepared using word processors or similar devices, and printed on A4-size portrait (vertical) sheets of paper. The length of the manuscript shall be, about 6 printed pages including figures, tables, and photographs.

3.2.4 Research papers and editorials shall have front covers and the category of the articles (research paper or editorial) shall be stated clearly on the cover sheets.

3.2.5 The title should be about 10-20 Japanese characters (5-10 English words), and readily understandable for a diverse readership background. Research papers shall have subtitles of about 15-25 Japanese characters (7-15 English words) to help recognition by specialists.

3.2.6 The abstract should include the thoughts behind the integration of technological elements and the reason for their selection as well as the scenario for utilizing the research results in society.

3.2.7 The abstract should be 300 Japanese characters or less (125 English words). The Japanese abstract may be omitted in the English edition.

3.2.8 The main text should be about 9,000 Japanese characters (3,400 English words).

3.2.9 The article submitted should be accompanied by profiles of all authors, of about 200 Japanese characters (75 English words) for each author. The essential contribution of each author to the paper should also be included. Confirm that all persons who have made essential contributions to the paper are included.

3.2.10 Discussion with reviewers regarding the research paper content shall be done openly with names of reviewers disclosed, and the Editorial Board will edit the highlights of the review process to about 3,000 Japanese characters (1,200 English words) or a maximum of 2 pages. The edited discussion will be attached to the main body of the paper as part of the article.

3.2.11 If there are reprinted figures, graphs or citations from other papers, prior permission for citation must be obtained and should be clearly stated in the paper, and the sources should be listed in the reference list. A copy of the permission should be sent to the Publishing Secretariat. All verbatim quotations should be placed in quotation marks or marked clearly within the paper.

### 3.3 Format

3.3.1 The headings for chapters should be 1, 2, 3..., for subchapters, 1.1, 1.2, 1.3..., for sections, 1.1.1, 1.1.2, 1.1.3, for subsections, 1.1.1.1, 1.1.1.2, 1.1.1.3.

3.3.2 The chapters, subchapters, and sections should be enumerated. There should be one line space before each paragraph.

3.3.3 Figures, tables, and photographs should be enumerated. They should each have a title and an explanation (about 20-40 Japanese characters or 10-20 English words), and their positions in the text should be clearly indicated.

3.3.4 For figures, image files (resolution 350 dpi or higher) should be submitted. In principle, the final print will be in black and white.

3.3.5 For photographs, image files (resolution 350 dpi or higher) should be submitted. In principle, the final print will be in black and white.

3.3.6 References should be listed in order of citation in the main text.

Journal – [No.] Author(s): Title of article, *Title of journal* (italic), Volume(Issue), Starting page-Ending page (Year of publication).

Book – [No.] Author(s): *Title of book* (italic), Starting page-Ending page, Publisher, Place of Publication (Year of publication).

Website – [No.] Author(s) name (updating year): Title of a web page, Name of a website (The name of a website is possible to be omitted when it is the same as an author name), URL, Access date.

## 4 Submission

One printed copy or electronic file (Word file) of manuscript with a checklist attached should be submitted to the following address:

*Synthesiology* Editorial Board  
c/o Website and Publication Office, Public Relations  
Department, National Institute of Advanced Industrial  
Science and Technology(AIST)  
Tsukuba Central 2 , 1-1-1 Umezono, Tsukuba 305-8568  
E-mail: synthesiology-ml@aist.go.jp  
The submitted article will not be returned.

## 5 Proofreading

Proofreading by author(s) of articles after typesetting is complete will be done once. In principle, only correction of printing errors are allowed in the proofreading stage.

## 6 Responsibility

The author(s) will be solely responsible for the content of the contributed article.

## 7 Copyright

The copyright of the articles published in “*Synthesiology*” and “*Synthesiology English edition*” shall belong to the National Institute of Advanced Industrial Science and Technology(AIST).

Inquiries:

*Synthesiology* Editorial Board  
c/o Website and Publication Office, Public Relations  
Department, National Institute of Advanced Industrial  
Science and Technology(AIST)  
Tel: +81-29-862-6217 Fax: +81-29-862-6212  
E-mail: synthesiology-ml@aist.go.jp

**Vol.7 table of contents (2014)****Vol.7 No.1****Research papers**

- Open foundry to spur open-innovation  
 – *Establishment of a foundry to realize an innovative cooperation platform and development of its sustainable management strategy* –  
 - - - H. AKINAGA 1-11
- Development of an advanced sewage sludge incinerator, “turbocharged fluidized bed incinerator”  
 – *The role of AIST in the development of a new system* –  
 - - - Y. SUZUKI, T. MURAKAMI and A. KITAJIMA 12-21
- A novel material design system method for on-demand material development  
 – *A method born from a development field* –  
 - - - T. INADA and T. MATSUO 22-29
- Towards large-capacity, energy-efficient, and sustainable communication networks  
 – *Network topology research for dynamic optical paths* –  
 - - - K. ISHII, J. KURUMIDA and S. NAMIKI 30-43

**Vol.7 No.2****Research papers**

- A social system for production and utilization of thermophysical quantity data  
 – *Measurement technology, metrological standard, standardization of measurement method, and database for thermal diffusivity by laser flash method* –  
 - - - T. BABA and M. AKOSHIMA 49-64
- National standards of length for high-capacity optical fiber communication systems  
 – *Development of fiber-based optical frequency combs* –  
 - - - H. INABA, A. ONAE and FL. HONG 65-78
- Research and development of solar hydrogen production  
 – *Toward the realization of ingenious photocatalysis-electrolysis hybrid system* –  
 - - - K. SAYAMA and Y. MISEKI 79-91
- Methodology for designing cryptographic systems with advanced functionality based on a modular approach  
 – *Towards reducing the barrier to introducing newly-designed cryptographic schemes into real-world systems* –  
 - - - G. HANAOKA, S. OHATA, T. MATSUDA, K. NUIDA and N. ATTRAPADUNG 92-104
- Development of lectin microarray, an advanced system for glycan profiling  
 – *From frontal affinity chromatography to evanescent wave excitation fluorescence detection method* –  
 - - - J. HIRABAYASHI 105-117
- Development of a household high-definition video transmission system based on ballpoint-pen technology  
 – *A low cost, easily deployed optical connection using a ballpoint-pen type interconnect* –  
 - - - T. TOMA, H. TAKIZUKA, T. TORIKAI, H. SUZUKI, T. OGI and Y. KOIKE 118-128

**Vol.7 No.3****Research papers**

- Development of a stable growth factor suitable for radioprotection  
 — *Drug development-aimed R&D at a basic research institute* —  
 --- T. IMAMURA 134 - 148
- Development of a protein array for autoantibody profiling of blood  
 — *Comprehensive disease diagnosis using the body's defense system* —  
 --- Y. KAWAKAMI and N. GOSHIMA 149 - 157
- Technological development of internal heat-integrated distillation column (HIDiC)  
 — *Substantive research of application to a bench plant of bioethanol distillation* —  
 --- K. KATAOKA and H. NODA 158 - 173
- Secure password authentication schemes and their applications  
 — *How to achieve security with short passwords* —  
 --- K. KOBARA and S.H. SHIN 174 - 184
- Development of environmentally-friendly surface modification technology  
 — *Practical realization of novel oleophobic coatings without relying on perfluorinated compounds and surface texturing* —  
 --- A. HOZUMI and C. URATA 185 - 193

**Vol.7 No.4****Research papers**

- New research trends in artifactology  
 — *Modeling of individuals and socialization technology* —  
 --- J. OTA, N. NISHINO, T. HARA and T. FUJITA 200 - 209
- Mental fatigue measurement as application software on consumer devices  
 — *Introducing reliable fatigue index to daily life* —  
 --- S. IWAKI and N. HARADA 210 - 217
- Development of evaluation technologies for sedimentary characteristics  
 — *Applicability of the technologies to the assessment of methane hydrate sediments* —  
 --- N. TENMA 218 - 228
- International standardization of four dimensional radiotherapy system  
 — *Enhancement of effects of irradiation and assurance of safety* —  
 --- Y. HIRATA, N. MIYAMOTO, M. SHIMIZU, M. YOSHIDA, K. HIRAMOTO,  
 Y. ICHIKAWA, S. KANEKO, T. SASAGAWA, M. HIRAOKA and H. SHIRATO 229 - 238
- Preparation of superconducting films by metal organic deposition  
 — *Research and development towards a fault current limiter and other electric devices* —  
 --- T. MANABE, M. SOHMA, I. YAMAGUCHI, H. MATSUI, T. TSUCHIYA and T. KUMAGAI 239 - 250

## Letter from the editor

We deliver you *Synthesiology* Volume 7 Issue 4 that carries five research papers. Please read the “Highlights of the Papers” that is a summary prepared by the Editorial Board at the beginning of the journal. The addition of the highlights started in the previous issue. As I was writing this “Letter,” there was wonderful news. Three Japanese researchers received the Nobel Prize in Physics for the invention and product realization of the blue light emitting diode that enables white light sources. The scientific findings such as the crystallization of gallium nitride were accumulated and became technological elements. These technological elements were integrated with passion, tenacity, and decisiveness of many stakeholders, to finally become a value accepted by society. It is a grand product of synthetic research that is the essence being pursued in *Synthesiology*.

The main characteristic of *Synthesiology* is that it presents a story of the process whereby a new social value is set as a goal and the technological elements are integrated through various processes. The reviewers play the role of making a decision in place of society under diverse standards for decision-making. They do this to determine whether the structure of the paper comprises a scenario that allows realization of a social value. Their responsibility is extremely heavy. I particularly pay attention to the “Discussion with the Reviewers” at the end of the paper, which the senior editor of the previous issue also mentioned. In principle, the reviewers’ names and the peer review comments are almost never publicized in an academic journal. However, *Synthesiology* publicizes the reviewers’ identity and the

discussion contents that may allow the readers to see the essence of the logic. In reality, the discussions go back and forth several times, and finally, the reviewers, as faithfully as possible and with permission from the authors, summarize the questions, comments, and answers from the authors that are necessary to create the final version of the papers.

In the paper for artifactology, the reviewer advised the author to change the perspective in the logical development, and in the paper for the fatigue measurement system that can be used in daily life, the reviewer boldly indicated the points that were unclear and requested corrections. In the papers for methane hydrate development and superconducting film by metal organic deposition, the reviewers requested changes to enable understanding by the general readers, specifically, to add the background of technologies inside and outside of Japan for methane hydrate and to provide categorization of the latest technology for the MOD method. In the paper for four-dimensional radiotherapy system, the reviewer indicated a point of argument that surpassed the authors’ initial proposal, and received the authors’ acknowledgement and understanding for this indication. Reading the “Discussion with Reviewers” that adds transparency to the review process before the actual paper will allow the readers to experience the thrill of this journal. To learn about the process of establishing the “Discussion with Reviewers” and its significance, please refer to the explanations in the “Preface” and “Message from the Editorial Board” (Vol. 1 Issue 1), and the “Roundtable Discussion” (Vol. 5 Issue 3).

(Toshimi SHIMIZU, Executive Editor)

**Synthesiology - English edition Vol. 7 No. 4, Mar. 2015**

Edited by *Synthesiology* Editorial Board

Published by National Institute of Advanced Industrial Science and Technology (AIST)

---

Edited by *Synthesiology* Editorial Board

Published by National Institute of Advanced Industrial Science and Technology (AIST)

*Synthesiology* Editorial Board

Editor in Chief: T. KANAYAMA

Senior Executive Editor: M. SETO, N. YUMOTO

Executive Editors: C. KURIMOTO, T. SHIMIZU, M. TANAKA, S. TOGASHI, H. HATORI,  
M. AKAMATSU, F. UEDA (New Energy and Industrial Technology  
Development Organization), A. OKADA (Sumitomo Chemical  
Company, Limited), N. KOBAYASHI (Waseda University), T. MAENO  
(Keio University), M. YAMAZAKI, M. TAKAHASHI

Editors: H. AKOH, S. ABE, S. ICHIMURA (Nagoya University), K. UEDA (Hyogo Prefectural  
Institute of Technology), A. ONO, A. KAGEYAMA, S. KANEMARU, T. KUBO, N.  
KOHTAKE (Keio University), K. SAKAUE, H. TAO, M. TAKESHITA (New Energy  
and Industrial Technology Development Organization), H. TATEISHI, H. TAYA,  
(J-Space Inc.), K. CHIBA, E. TSUKUDA, H. NAKASHIMA (Future University  
Hakodate), S. NIKI, Y. HASEGAWA, Y. BABA (The University of Tokyo), T.  
MATSUI, Y. MITSUISHI, N. MURAYAMA, M. MOCHIMARU, Y. YANO, A. YABE, H.  
YOSHIKAWA (Japan Science and Technology Agency)

Publishing Secretariat: Publication Office, Public Relations Department, AIST

Contact: *Synthesiology* Editorial Board

c/o Website and Publication Office, Public Relations Department, AIST

Tsukuba Central 2, 1-1-1 Umezono, Tsukuba 305-8568, Japan

Tel: +81-29-862-6217 Fax: +81-29-862-6212

E-mail: [synthesiology-ml@aist.go.jp](mailto:synthesiology-ml@aist.go.jp)

URL: [http://www.aist.go.jp/aist\\_e/research\\_results/publications/synthesiology\\_e](http://www.aist.go.jp/aist_e/research_results/publications/synthesiology_e)

\*Reproduction in whole or in part without written permission is prohibited.



## Highlights of the Papers in *Synthesiology*

### Research papers

New research trends in artifactology

—*Modeling of individuals and socialization technology*—

J.OTA, N.NISHINO, T.HARA and T.FUJITA

Mental fatigue measurement as application software on consumer devices

—*Introducing reliable fatigue index to daily life*—

S.IWAKI and N.HARADA

Development of evaluation technologies for sedimentary characteristics

—*Applicability of the technologies to the assessment of methane hydrate sediments*—

N.TENMA

International standardization of four dimensional radiotherapy system

—*Enhancement of effects of irradiation and assurance of safety*—

Y.HIRATA, N.MIYAMOTO, M.SHIMIZU, M.YOSHIDA, K.HIRAMOTO, Y.ICHIKAWA,  
S.KANEKO, T.SASAGAWA, M.HIRAOKA and H.SHIRATO

Preparation of superconducting films by metal organic deposition

—*Research and development towards a fault current limiter and other electric devices*—

T.MANABE, M.SOHMA, I.YAMAGUCHI, H.MATSUI, T.TSUCHIYA and T.KUMAGAI

### Messages from the editorial board

#### Editorial policy

#### Instructions for authors

“*Synthesiology-English edition*” is a translated version of “*Synthesiology*,” which is published quarterly, ISSN 1882-6229, by AIST. Papers or articles published in “*Synthesiology-English edition*” appear approximately four months after the publication of the original “*Synthesiology*.”